

# Dell™ Dimension™ 1100/B110

## Owner's Manual

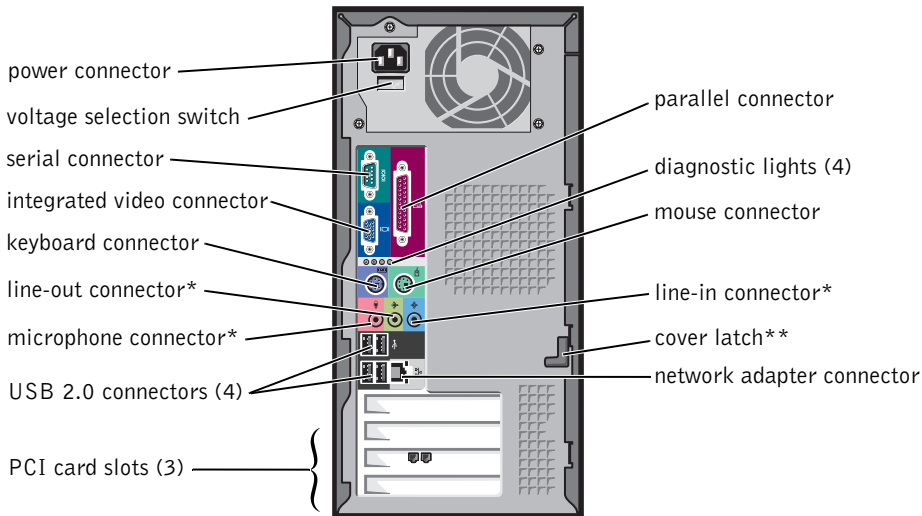
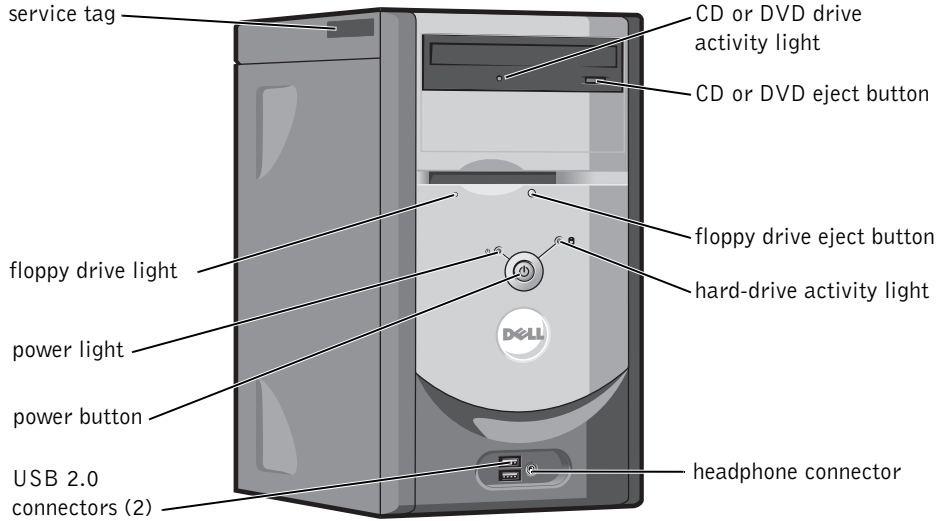

\*On computers with integrated sound.

\*\*May not be present on all computers.

Model DMC

## Notes, Notices, and Cautions



**NOTE:** A NOTE indicates important information that helps you make better use of your computer.



**NOTICE:** A NOTICE indicates either potential damage to hardware or loss of data and tells you how to avoid the problem.



**CAUTION:** A CAUTION indicates a potential for property damage, personal injury, or death.

If you purchased a Dell™ n Series computer, any references in this document to Microsoft® Windows® operating systems are not applicable.

---

**Information in this document is subject to change without notice.**

© 2006 Dell Inc. All rights reserved.

Reproduction in any manner whatsoever without the written permission of Dell Inc. is strictly forbidden.

Trademarks used in this text: *Dell*, the *DELL* logo, *Inspiron*, *Dell Precision*, *Dimension*, *OptiPlex*, *Latitude*, *PowerEdge*, *PowerVault*, *PowerApp*, *PowerConnect*, and *Dell OpenManage* are trademarks of Dell Inc.; *Intel*, *Pentium*, and *Celeron* are registered trademarks of Intel Corporation; *Microsoft*, *Windows*, and *Outlook* are registered trademarks of Microsoft Corporation.

Other trademarks and trade names may be used in this document to refer to either the entities claiming the marks and names or their products. Dell Inc. disclaims any proprietary interest in trademarks and trade names other than its own.

Model DMC

September 2006

P/N WD492

Rev. A04

# Contents

<b>Finding Information</b> . . . . .	<b>7</b>
<b>1 Setting Up and Using Your Computer</b>	
<b>Setting Up a Printer</b> . . . . .	<b>9</b>
Printer Cable . . . . .	9
Connecting a USB Printer. . . . .	9
Connecting a Parallel Printer. . . . .	10
<b>Setting Up a Home and Office Network</b> . . . . .	<b>11</b>
Connecting to a Network Adapter . . . . .	11
Network Setup Wizard . . . . .	12
<b>Connecting to the Internet</b> . . . . .	<b>12</b>
Setting Up Your Internet Connection . . . . .	13
<b>Playing CDs and DVDs</b> . . . . .	<b>14</b>
Adjusting the Volume . . . . .	15
Adjusting the Picture . . . . .	16
<b>Copying CDs and DVDs.</b> . . . . .	<b>16</b>
How to Copy a CD or DVD. . . . .	16
Using Blank CDs and DVDs. . . . .	17
Helpful Tips . . . . .	18
<b>Hyper-Threading</b> . . . . .	<b>18</b>
<b>2 Solving Problems</b>	
<b>Troubleshooting Tips.</b> . . . . .	<b>19</b>
<b>Battery Problems.</b> . . . . .	<b>19</b>
<b>Drive Problems.</b> . . . . .	<b>19</b>
CD and DVD drive problems . . . . .	20
Hard drive problems . . . . .	21
<b>E-Mail, Modem, and Internet Problems</b> . . . . .	<b>21</b>

<b>Error Messages</b> . . . . .	<b>22</b>
<b>IEEE 1394 Device Problems</b> . . . . .	<b>23</b>
<b>Keyboard Problems</b> . . . . .	<b>24</b>
<b>Lockups and Software Problems</b> . . . . .	<b>24</b>
The computer does not start up . . . . .	24
The computer stops responding . . . . .	24
A program stops responding . . . . .	25
A program crashes repeatedly . . . . .	25
A program is designed for an earlier Windows operating system . . . . .	25
A solid blue screen appears . . . . .	25
Other software problems . . . . .	26
<b>Memory Problems</b> . . . . .	<b>26</b>
<b>Mouse Problems</b> . . . . .	<b>27</b>
<b>Network Problems</b> . . . . .	<b>28</b>
<b>Power Problems</b> . . . . .	<b>28</b>
<b>Printer Problems</b> . . . . .	<b>29</b>
<b>Scanner Problems</b> . . . . .	<b>30</b>
<b>Sound and Speaker Problems</b> . . . . .	<b>31</b>
No sound from speakers . . . . .	31
No sound from headphones . . . . .	32
<b>Video and Monitor Problems</b> . . . . .	<b>32</b>
If the screen is blank . . . . .	32
If the screen is difficult to read . . . . .	33

### 3 Advanced Troubleshooting

<b>Diagnostic Lights</b> . . . . .	<b>35</b>
<b>Dell Diagnostics</b> . . . . .	<b>38</b>
Dell Diagnostics Main Menu . . . . .	38
<b>Drivers</b> . . . . .	<b>40</b>
What Is a Driver? . . . . .	40
Identifying Drivers . . . . .	40
Reinstalling Drivers . . . . .	40

<b>Restoring Your Operating System</b> . . . . .	<b>41</b>
Using Microsoft Windows XP System Restore . . . . .	42
Using Dell PC Restore by Symantec . . . . .	43
Using the Operating System CD. . . . .	45
<b>Resolving Software and Hardware Incompatibilities</b> . . . . .	<b>46</b>

## 4 Removing and Installing Parts

<b>Before You Begin</b> . . . . .	<b>47</b>
Recommended Tools . . . . .	47
Turning Off Your Computer . . . . .	47
Before Working Inside Your Computer . . . . .	48
<b>Front and Back View of the Computer</b> . . . . .	<b>49</b>
Front View. . . . .	49
Back View. . . . .	50
<b>Removing the Computer Cover</b> . . . . .	<b>52</b>
<b>Inside View of Your Computer</b> . . . . .	<b>53</b>
<b>System Board Components</b> . . . . .	<b>54</b>
<b>Memory</b> . . . . .	<b>55</b>
DDR Memory Overview. . . . .	55
Memory Installation Guidelines . . . . .	55
Installing Memory. . . . .	56
<b>Cards</b> . . . . .	<b>58</b>
PCI Cards . . . . .	58
<b>Front Panel</b> . . . . .	<b>61</b>
Removing the Front Panel. . . . .	62
Removing the Front-Panel Insert . . . . .	63
Reattaching the Front Panel . . . . .	64
<b>Drives</b> . . . . .	<b>64</b>
General Installation Guidelines . . . . .	65
Connecting Drive Cables . . . . .	65
<b>Hard Drive</b> . . . . .	<b>66</b>
Removing a Hard Drive . . . . .	66
Installing a Hard Drive . . . . .	68

<b>Floppy Drive</b> . . . . .	<b>70</b>
Removing a Floppy Drive . . . . .	70
Installing a Floppy Drive . . . . .	71
<b>CD/DVD Drive</b> . . . . .	<b>73</b>
Removing a CD/DVD Drive . . . . .	73
Installing a CD/DVD Drive . . . . .	74
Adding a Second CD or DVD Drive . . . . .	75
<b>Battery</b> . . . . .	<b>77</b>
<b>Replacing the Computer Cover</b> . . . . .	<b>78</b>

## 5 Appendix

<b>Specifications</b> . . . . .	<b>79</b>
<b>System Setup</b> . . . . .	<b>82</b>
Overview . . . . .	82
Entering System Setup . . . . .	83
System Setup Options . . . . .	84
Boot Sequence . . . . .	88
<b>Clearing Forgotten Passwords</b> . . . . .	<b>90</b>
<b>Cleaning Your Computer</b> . . . . .	<b>91</b>
Computer, Keyboard, and Monitor . . . . .	91
Mouse . . . . .	91
Floppy Drive . . . . .	91
CDs and DVDs . . . . .	92
<b>Dell Technical Support Policy (U.S. Only)</b> . . . . .	<b>92</b>
Definition of "Dell-Installed" Software and Peripherals . . . . .	92
Definition of "Third-Party" Software and Peripherals . . . . .	93
<b>FCC Notices (U.S. Only)</b> . . . . .	<b>93</b>
Class A . . . . .	93
Class B . . . . .	93
FCC Identification Information . . . . .	94
<b>Contacting Dell</b> . . . . .	<b>94</b>

Index . . . . .	113
-----------------	-----

# Finding Information

 **NOTE:** Some features or media may be optional and may not ship with your computer. Some features or media may not be available in certain countries.

 **NOTE:** Additional information may ship with your computer.

---

## What Are You Looking For?

- Warranty information
- Terms and Conditions (U.S. only)
- Safety instructions
- Regulatory information
- Ergonomics information
- End User License Agreement

## Find It Here

### Dell™ Product Information Guide



- 
- How to set up my computer

## Setup Diagram

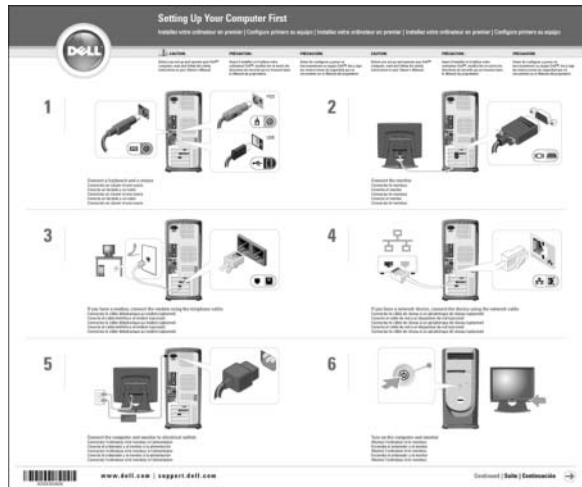

---

## What Are You Looking For?

- Service Tag and Express Service Code
- Microsoft Windows License Label

## Find It Here

### Service Tag and Microsoft® Windows® License

These labels are located on your computer.

- Use the Service Tag to identify your computer when you use [support.dell.com](http://support.dell.com) or contact technical support.
- Enter the Express Service Code to direct your call when contacting technical support.



- 
- Solutions — Troubleshooting hints and tips, articles from technicians, and online courses, frequently asked questions
  - Community — Online discussion with other Dell customers
  - Upgrades — Upgrade information for components, such as memory, the hard drive, and the operating system
  - Customer Care — Contact information, service call and order status, warranty, and repair information
  - Service and support — Service call status and support history, service contract, online discussions with technical support
  - Reference — Computer documentation, details on my computer configuration, product specifications, and white papers
  - Downloads — Certified drivers, patches, and software updates

### Dell Support Website — [support.dell.com](http://support.dell.com)

**NOTE:** Select your region to view the appropriate support site.

**NOTE:** Corporate, government, and education customers can also use the customized Dell Premier Support website at [premier.support.dell.com](http://premier.support.dell.com).

- 
- How to use Windows XP
  - How to work with programs and files
  - How to personalize my desktop

### Windows Help and Support Center

- 1 Click the **Start** button and click **Help and Support**.
  - 2 Type a word or phrase that describes your problem and click the arrow icon.
  - 3 Click the topic that describes your problem.
  - 4 Follow the instructions on the screen.
-



# Setting Up and Using Your Computer

## Setting Up a Printer

 **NOTICE:** Complete the operating system setup before you connect a printer to the computer.

See the documentation that came with the printer for setup information, including how to:

- Obtain and install updated drivers.
- Connect the printer to the computer.
- Load paper and install the toner or ink cartridge.
- Contact the printer manufacturer for technical assistance.

### Printer Cable

Your printer connects to your computer with either a USB cable or a parallel cable. Your printer may not come with a printer cable, so if you purchase a cable separately, ensure that it is compatible with your printer. If you purchased a printer cable at the same time you purchased your computer, the cable may arrive in the computer box.

### Connecting a USB Printer

 **NOTE:** You can connect USB devices while the computer is turned on.

- 1 Complete the operating system setup if you have not already done so.
- 2 Install the printer driver if necessary. See the documentation that came with your printer.

- 3 Attach the USB printer cable to the USB connectors on the computer and the printer. The USB connectors fit only one way.

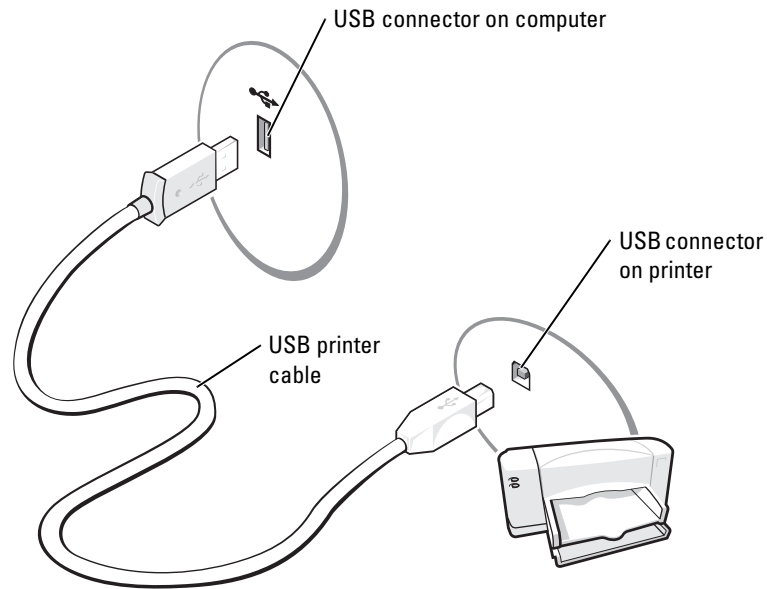

### Connecting a Parallel Printer

- 1 Complete the operating system setup, if you have not already done so.
- 2 Turn off the computer (see page 47).
- ➔ **NOTICE:** For best results, use a 3-m (10-ft) or shorter parallel cable.
- 3 Attach the parallel printer cable to the parallel connector on the computer and tighten the two screws. Attach the cable to the connector on the printer and snap the two clips into the two notches.

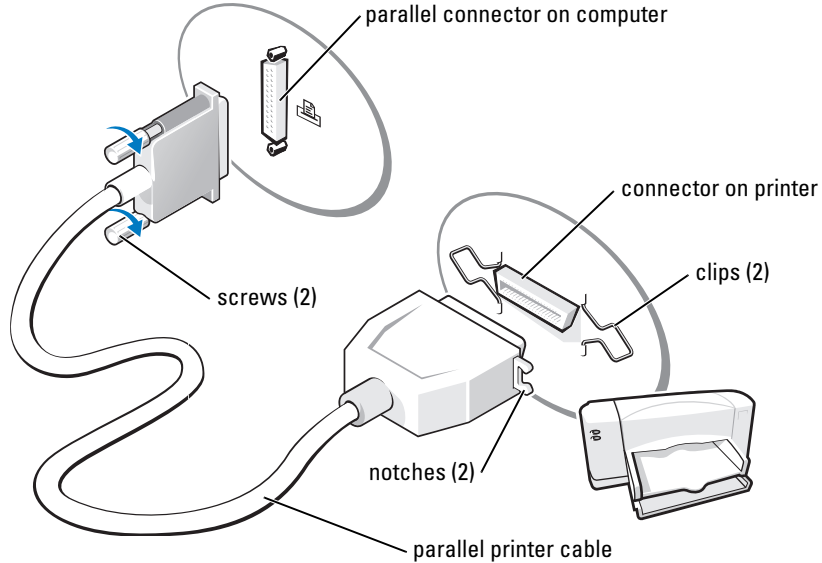

- 4 Turn on the printer and then turn on the computer. If the **Add New Hardware Wizard** window appears, click **Cancel**.
- 5 Install the printer driver if necessary. See the documentation that came with your printer.

## Setting Up a Home and Office Network

### Connecting to a Network Adapter

 **NOTE:** Plug the network cable into the network adapter connector on the computer. Do not plug the network cable into the modem connector on the computer. Do not plug a network cable into a telephone wall jack.

- 1 Connect the network cable to the network adapter connector on the back of your computer. Insert the cable until it clicks into place, and then gently pull it to ensure that it is secure.
- 2 Connect the other end of the network cable to a network device.

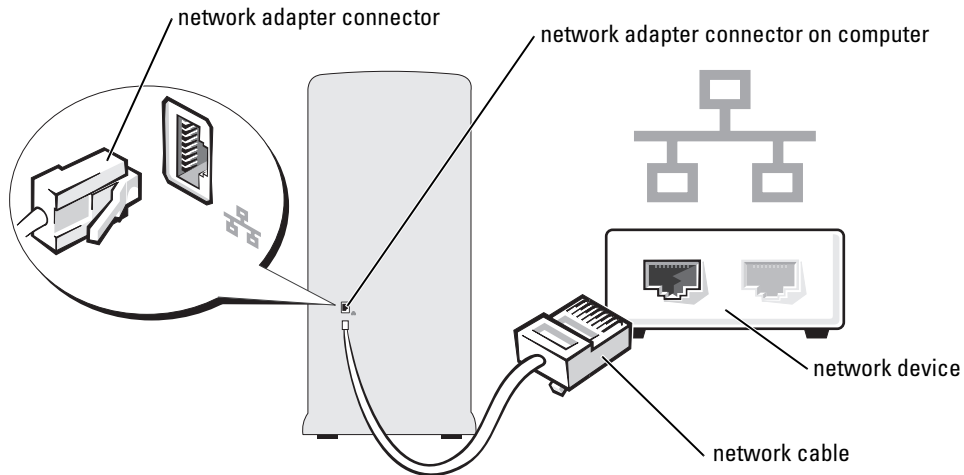

## Network Setup Wizard

The Microsoft® Windows® XP operating system provides a Network Setup Wizard to guide you through the process of sharing files, printers, or an Internet connection between computers in a home or small office.

- 1 Click the **Start** button, point to **All Programs**→ **Accessories**→ **Communications**, and then click **Network Setup Wizard**.
- 2 On the welcome screen, click **Next**.
- 3 Click **Checklist for creating a network**.

 **NOTE:** Selecting the connection method **This computer connects directly to the Internet** enables the integrated firewall provided with Windows XP Service Pack 1 (SP1).

- 4 Complete the checklist and required preparations.
- 5 Return to the Network Setup Wizard and follow the instructions on the screen.

## Connecting to the Internet

 **NOTE:** ISPs and ISP offerings vary by country.

To connect to the Internet, you need a modem or network connection and an Internet service provider (ISP), such as AOL or MSN. Your ISP will offer one or more of the following Internet connection options:

- Dial-up connections that provide Internet access through a telephone line. Dial-up connections are considerably slower than DSL and cable modem connections.
- DSL connections that provide high-speed Internet access through your existing telephone line. With a DSL connection, you can access the Internet and use your telephone on the same line simultaneously.
- Cable modem connections that provide high-speed Internet access through your local cable TV line.

If you are using a dial-up connection, connect a telephone line to the modem connector on your computer and to the telephone wall jack before you set up your Internet connection. If you are using a DSL or cable modem connection, contact your ISP for setup instructions.

## Setting Up Your Internet Connection

To set up an AOL or MSN connection:

- 1 Save and close any open files, and exit any open programs.
- 2 Double-click the **MSN Explorer** or **AOL** icon on the Microsoft® Windows® desktop.
- 3 Follow the instructions on the screen to complete the setup.

If you do not have an **MSN Explorer** or **AOL** icon on your desktop or if you want to set up an Internet connection with a different ISP:

- 1 Save and close any open files, and exit any open programs.
- 2 Click the **Start** button and click **Internet Explorer**.  
The **New Connection Wizard** appears.
- 3 Click **Connect to the Internet**.
- 4 In the next window, click the appropriate option:
  - If you do not have an ISP and want to select one, click **Choose from a list of Internet service providers (ISPs)**.
  - If you have already obtained setup information from your ISP but you did not receive a setup CD, click **Set up my connection manually**.
  - If you have a CD, click **Use the CD I got from an ISP**.
- 5 Click **Next**.

If you selected **Set up my connection manually**, continue to step 6. Otherwise, follow the instructions on the screen to complete the setup.



**NOTE:** If you do not know which type of connection to select, contact your ISP.

- 6 Click the appropriate option under **How do you want to connect to the Internet?**, and then click **Next**.
- 7 Use the setup information provided by your ISP to complete the setup.

If you are having problems connecting to the Internet, see "E-Mail, Modem, and Internet Problems" on page 21. If you cannot connect to the Internet but have successfully connected in the past, the ISP might have a service outage. Contact your ISP to check the service status, or try connecting again later.

## Playing CDs and DVDs

**➡ NOTICE:** Do not press down on the CD or DVD tray when you open or close it. Keep the tray closed when you are not using the drive.

**➡ NOTICE:** Do not move the computer when you are playing CDs or DVDs.

- 1 Press the eject button on the front of the drive.
- 2 Place the disc, label side up, in the center of the tray.









- 3 Press the eject button or gently push in the tray.

To format CDs for storing data, to create music CDs, or to copy CDs, see the CD software that came with your computer.



**✍ NOTE:** Ensure that you follow all copyright laws when you create CDs.

A CD player includes the following basic buttons:

---

	Play
	Move backward within the current track
	Pause
	Move forward within the current track
	Stop
	Go to the previous track











---

	Eject
	Go to the next track

---

A DVD player includes the following basic buttons:

---

	Stop
	Restart the current chapter
	Play
	Fast forward
	Pause
	Fast reverse
	Advance a single frame while in pause mode
	Go to the next title or chapter
	Continuously play the current title or chapter
	Go to the previous title or chapter
	Eject

---

For more information on playing CDs or DVDs, click **Help** on the CD or DVD player (if available).

## Adjusting the Volume

 **NOTE:** When the speakers are muted, you do not hear the CD or DVD playing.

- 1 Click the **Start** button, point to **All Programs** → **Accessories** → **Entertainment**, and then click **Volume Control**.
- 2 In the **Volume Control** window, click and drag the bar in the **Volume Control** column and slide it up or down to increase or decrease the volume.

For more information on volume control options, click **Help** in the **Volume Control** window.

## Adjusting the Picture

If an error message notifies you that the current resolution and color depth are using too much memory and preventing DVD playback, adjust the display properties:

- 1 Click the **Start** button and click **Control Panel**.
- 2 Under **Pick a category**, click **Appearance and Themes**.
- 3 Under **Pick a task...**, click **Change the screen resolution**.
- 4 In the **Display Properties** window, click and drag the bar in **Screen resolution** to change the setting to 800 by 600 pixels.
- 5 Click the drop-down menu under **Color quality**, and then click **Medium (16 bit)**.
- 6 Click **OK**.

## Copying CDs and DVDs

 **NOTE:** Please observe all copyright laws when creating CDs or DVDs.

This section applies only to computers that have a CD-RW, DVD +/-RW, or CD-RW/DVD (combo) drive.

 **NOTE:** The types of CD or DVD drives offered by Dell may vary by country.

The following instructions explain how to make an exact copy of a CD or DVD. You can also use Sonic DigitalMedia for other purposes, such as creating music CDs from audio files stored on your computer or backing up important data. For help, open Sonic DigitalMedia and then click the question mark icon in the upper-right corner of the window.

### How to Copy a CD or DVD

 **NOTE:** CD-RW/DVD combo drives cannot write to DVD media. If you have a CD-RW/DVD combo drive and you experience recording problems, check for available software patches on the Sonic support website at [www.sonic.com](http://www.sonic.com).

The DVD-writable drives installed in Dell™ computers can write to and read DVD +/-R, DVD +/-RW and DVD+R DL (dual layer) media, but cannot write to and may not read DVD-RAM or DVD-R DL media.

 **NOTE:** Most commercial DVDs have copyright protection and cannot be copied using Sonic DigitalMedia.

- 1 Click the **Start** button, point to **All Programs**→ **Sonic**→ **DigitalMedia Projects** and then click **Copy**.
- 2 Under the **Copy** tab click **Disc Copy**.
- 3 To copy the CD or DVD:
  - *If you have one CD or DVD drive*, ensure that the settings are correct and click the **Disc Copy** button. The computer will read your source CD or DVD and copy the data to a temporary folder on your computer hard drive.

When prompted, insert a blank CD or DVD into the drive and click **OK**.



- *If you have two CD or DVD drives, select the drive into which you have inserted your source CD or DVD and click the **Disc Copy** button. The computer copies the data from the source CD or DVD to the blank CD or DVD.*

Once you have finished copying the source CD or DVD, the CD or DVD that you have created will automatically eject.

## Using Blank CDs and DVDs

CD-RW drives can write to CD recording media only (including high-speed CD-RW) while DVD-writable drives can write to both CD and DVD recording media.

Use blank CD-Rs to record music or permanently store data files. After creating a CD-R, you cannot write to that CD-R again (see the Sonic documentation for more information). Use blank CD-RWs to write to CDs or to erase, rewrite, or update data on CDs.

Blank DVD+/-Rs can be used to permanently store large amounts of information. After you create a DVD+/-R disc, you may not be able to write to that disc again if the disc is "finalized" or "closed" during the final stage of the disc creation process. Use blank DVD+/-RWs if you plan to erase, rewrite, or update information on that disc later.

### CD-Writable Drives

Media Type	Read	Write	Rewritable
CD-R	Yes	Yes	No
CD-RW	Yes	Yes	Yes

### DVD-Writable Drives

Media Type	Read	Write	Rewritable
CD-R	Yes	Yes	No
CD-RW	Yes	Yes	Yes
DVD+R	Yes	Yes	No
DVD-R	Yes	Yes	No
DVD+RW	Yes	Yes	Yes
DVD-RW	Yes	Yes	Yes
DVD+R DL	Yes	Yes	No

## Helpful Tips

- Use Microsoft® Windows® Explorer to drag and drop files to a CD-R or CD-RW only after you start Sonic DigitalMedia and open a DigitalMedia project.
- Use CD-Rs to burn music CDs that you want to play in regular stereos. CD-RWs do not play in most home or car stereos.
- You cannot create audio DVDs with Sonic DigitalMedia.
- Music MP3 files can be played only on MP3 players or on computers that have MP3 software installed.
- Commercially available DVD players used in home theater systems may not support all available DVD formats. For a list of formats supported by your DVD player refer to the documentation provided with your DVD player or contact the manufacturer.
- Do not burn a blank CD-R or CD-RW to its maximum capacity; for example, do not copy a 650-MB file to a blank 650-MB CD. The CD-RW drive needs 1-2 MB of the blank space to finalize the recording.
- Use a blank CD-RW to practice CD recording until you are familiar with CD recording techniques. If you make a mistake, you can erase the data on the CD-RW and try again. You can also use blank CD-RWs to test music file projects before you record the project permanently to a blank CD-R.

See the Sonic website at [www.sonic.com](http://www.sonic.com) for additional information.

## Hyper-Threading

Hyper-Threading is an Intel® technology that can enhance overall computer performance by allowing one physical processor to function as two logical processors, capable of performing certain tasks simultaneously. It is recommended that you use the Microsoft® Windows® XP Service Pack 1 (SP1) or later operating system because Windows XP is optimized to take advantage of Hyper-Threading technology. While many programs can benefit from Hyper-Threading, some programs have not been optimized for Hyper-Threading and may require an update from the software manufacturer. Contact the software manufacturer for updates and information about using Hyper-Threading with your software.

To determine if your computer is using Hyper-Threading technology:

- 1 Click the **Start** button, right-click **My Computer**, and then click **Properties**.
- 2 Click **Hardware** and click **Device Manager**.
- 3 In the **Device Manager** window, click the plus (+) sign next to **Processors**. If Hyper-Threading is enabled, the processor is listed twice.

You can enable or disable Hyper-Threading through system setup. For more information on accessing system setup, see page 83. For more information on Hyper-Threading, search the Knowledge Base on the Dell Support website at [support.dell.com](http://support.dell.com).

# Solving Problems

## Troubleshooting Tips

Follow these tips when you troubleshoot your computer:

- If you added or removed a part before the problem started, review the installation procedures and ensure that the part is correctly installed.
- If a peripheral device does not work, ensure that the device is properly connected.
- If an error message appears on the screen, write down the exact message. This message may help technical support personnel diagnose and fix the problem(s).
- If an error message occurs in a program, see the program's documentation.

## Battery Problems



**CAUTION:** There is a danger of a new battery exploding if it is incorrectly installed. Replace the battery only with the same or equivalent type recommended by the manufacturer. Discard used batteries according to the manufacturer's instructions.



**CAUTION:** Before you begin any of the procedures in this section, follow the safety instructions located in the *Product Information Guide*.

**REPLACE THE BATTERY** — If you have to repeatedly reset time and date information after turning on the computer, or if an incorrect time or date displays during start-up, replace the battery (see page 77). If the battery still does not work properly, contact Dell (see page 94).

## Drive Problems



**CAUTION:** Before you begin any of the procedures in this section, follow the safety instructions located in the *Product Information Guide*.

**ENSURE THAT MICROSOFT® WINDOWS® RECOGNIZES THE DRIVE** — Click the Start button and click My Computer. If the floppy, CD, or DVD drive, is not listed, perform a full scan with your antivirus software to check for and remove viruses. Viruses can sometimes prevent Windows from recognizing the drive.

#### **TEST THE DRIVE —**

- Insert another floppy disk, CD, or DVD to eliminate the possibility that the original one is defective.
- Insert a bootable floppy disk and restart the computer.

**CLEAN THE DRIVE OR DISK —** See the "Cleaning Your Computer" on page 91.

#### **CHECK THE CABLE CONNECTIONS**

**CHECK FOR RUN THE HARDWARE TROUBLESHOOTER —** See page 46.

**RUN THE DELL DIAGNOSTICS —** See page 38.

### **CD and DVD drive problems**



**NOTE:** High-speed CD or DVD drive vibration is normal and may cause noise, which does not indicate a defect in the drive or the CD or DVD.



**NOTE:** Because of different regions worldwide and different disc formats, not all DVD titles work in all DVD drives.

#### **ADJUST THE WINDOWS VOLUME CONTROL —**

- Click the speaker icon in the lower-right corner of your screen.
- Ensure that the volume is turned up by clicking the sidebar and dragging it up.
- Ensure that the sound is not muted by clicking any boxes that are checked.

**CHECK THE SPEAKERS AND SUBWOOFER —** See "Sound and Speaker Problems" on page 31.

### **Problems writing to a CD/DVD-RW drive**

**CLOSE OTHER PROGRAMS —** The CD/DVD-RW drive must receive a steady stream of data when writing. If the stream is interrupted, an error occurs. Try closing all programs before you write to the CD/DVD-RW.

**TURN OFF STANDBY MODE IN WINDOWS BEFORE WRITING TO A CD/DVD-RW DISC —** Search for the keyword *standby* in Windows Help (see page 8) for information on power management modes.

## Hard drive problems

### **RUN CHECK DISK** —

- 1 Click the **Start** button and click **My Computer**.
- 2 Right-click **Local Disk C:**.
- 3 Click **Properties**.
- 4 Click the **Tools** tab.
- 5 Under **Error-checking**, click **Check Now**.
- 6 Click **Scan for and attempt recovery of bad sectors**.
- 7 Click **Start**.

## E-Mail, Modem, and Internet Problems



**CAUTION:** Before you begin any of the procedures in this section, follow the safety instructions located in the *Product Information Guide*.



**NOTE:** Connect the modem to an analog telephone jack only. The modem does not operate while it is connected to a digital telephone network.

**CHECK THE MICROSOFT OUTLOOK® EXPRESS SECURITY SETTINGS** — If you cannot open your e-mail attachments:

- 1 In Outlook Express, click **Tools**, click **Options**, and then click **Security**.
- 2 Click **Do not allow attachments** to remove the checkmark.

### **CHECK THE TELEPHONE LINE CONNECTION** —

#### **CHECK THE TELEPHONE JACK** —

#### **CONNECT THE MODEM DIRECTLY TO THE TELEPHONE WALL JACK** —

#### **USE A DIFFERENT TELEPHONE LINE** —

- Verify that the telephone line is connected to the jack on the modem. (The jack has either a green label or a connector-shaped icon next to it.)
- Ensure that you hear a click when you insert the telephone line connector into the modem.
- Disconnect the telephone line from the modem and connect it to a telephone. Listen for a dial tone.
- If you have other telephone devices sharing the line, such as an answering machine, fax machine, surge protector, or line splitter, then bypass them and use the telephone to connect the modem directly to the telephone wall jack. If you are using a line that is 3 m (10 ft) or more in length, try a shorter one.

**RUN THE MODEM HELPER DIAGNOSTICS** — Click the **Start** button, point to **All Programs**, and then click **Modem Helper**. Follow the instructions on the screen to identify and resolve modem problems. (Modem Helper is not available on all computers.)

#### **VERIFY THAT THE MODEM IS COMMUNICATING WITH WINDOWS —**

- 1 Click the **Start** button and click **Control Panel**.
  - 2 Click **Printers and Other Hardware**.
  - 3 Click **Phone and Modem Options**.
  - 4 Click the **Modems** tab.
  - 5 Click the COM port for your modem.
  - 6 Click **Properties**, click the **Diagnostics** tab, and then click **Query Modem** to verify that the modem is communicating with Windows.
- If all commands receive responses, the modem is operating properly.

**ENSURE THAT YOU ARE CONNECTED TO THE INTERNET —** Ensure that you have subscribed to an Internet provider. With the Outlook Express e-mail program open, click **File**. If **Work Offline** has a checkmark next to it, click the checkmark to remove it and connect to the Internet. For help, contact your Internet service provider.

**SCAN THE COMPUTER FOR SPYWARE —** If you are experiencing slow computer performance, you frequently receive pop-up advertisements, or you are having problems connecting to the Internet, your computer might be infected with spyware. Use an antivirus program that includes anti-spyware protection (your program may require an upgrade) to scan the computer and remove spyware. For more information, go to [support.dell.com](http://support.dell.com) and search for the keyword *spyware*.

## **Error Messages**



**CAUTION:** Before you begin any of the procedures in this section, follow the safety instructions located in the *Product Information Guide*.

If the message is not listed, see the documentation for the operating system or the program that was running when the message appeared.

**A FILENAME CANNOT CONTAIN ANY OF THE FOLLOWING CHARACTERS: \ / : \* ? " < > | —** Do not use these characters in filenames.

**A REQUIRED .DLL FILE WAS NOT FOUND —** The program that you are trying to open is missing an essential file. To remove and then reinstall the program:

- 1 Click the **Start** button, click **Control Panel**, and then click **Add or Remove Programs**.
- 2 Select the program you want to remove.
- 3 Click the **Change or Remove Program** icon.
- 4 See the program documentation for installation instructions.

**drive letter : \ is not accessible. The device is not ready** — The drive cannot read the disk. Insert a disk into the drive and try again.

**INSERT BOOTABLE MEDIA** — Insert a bootable floppy disk or CD.

**NON-SYSTEM DISK ERROR** — Remove the floppy disk from the drive and restart your computer.

**NOT ENOUGH MEMORY OR RESOURCES. CLOSE SOME PROGRAMS AND TRY AGAIN** — Close all windows and open the program that you want to use. In some cases, you might have to restart your computer to restore computer resources. If so, run the program that you want to use first.

**OPERATING SYSTEM NOT FOUND** — Contact Dell (see page 94).

## IEEE 1394 Device Problems



**CAUTION:** Before you begin any of the procedures in this section, follow the safety instructions located in the *Product Information Guide*.

**ENSURE THAT THE CABLE FOR THE IEEE 1394 DEVICE IS PROPERLY INSERTED INTO THE DEVICE AND INTO THE CONNECTOR ON THE COMPUTER**

**ENSURE THAT THE IEEE 1394 DEVICE IS RECOGNIZED BY WINDOWS** —

- 1 Click the Start button and click Control Panel.
- 2 Click Printers and Other Hardware.  
If your IEEE 1394 device is listed, Windows recognizes the device.

**IF YOU HAVE PROBLEMS WITH A DELL IEEE 1394 DEVICE** — Contact Dell (see page 94).

**IF YOU HAVE PROBLEMS WITH AN IEEE 1394 DEVICE NOT PROVIDED BY DELL** — Contact the manufacturer of the IEEE 1394 device.

## Keyboard Problems

 **CAUTION:** Before you begin any of the procedures in this section, follow the safety instructions located in the *Product Information Guide*.

### CHECK THE KEYBOARD CABLE —

- Ensure that the keyboard cable is firmly connected to the computer.
- Shut down the computer (see page 47), reconnect the keyboard cable as shown on the setup diagram for your computer, and then restart the computer.
- Check the cable connector for bent or broken pins and for damaged or frayed cables. Straighten bent pins.
- Remove keyboard extension cables and connect the keyboard directly to the computer.

**TEST THE KEYBOARD** — Connect a properly working keyboard to the computer, and try using the keyboard.

**RUN THE HARDWARE TROUBLESHOOTER** — See page 46.

## Lockups and Software Problems

 **CAUTION:** Before you begin any of the procedures in this section, follow the safety instructions located in the *Product Information Guide*.

### The computer does not start up

**CHECK THE DIAGNOSTIC LIGHTS** — See page 35.

**ENSURE THAT THE POWER CABLE IS FIRMLY CONNECTED TO THE COMPUTER AND TO THE ELECTRICAL OUTLET**

### The computer stops responding

 **NOTICE:** You might lose data if you are unable to perform an operating system shutdown.

**TURN THE COMPUTER OFF** — If you are unable to get a response by pressing a key on your keyboard or moving your mouse, press and hold the power button for at least 8 to 10 seconds until the computer turns off. Then restart your computer.



## A program stops responding

### END THE PROGRAM —

- 1 Press <Ctrl><Shift><Esc> simultaneously.
- 2 Click **Applications**.
- 3 Click the program that is no longer responding.
- 4 Click **End Task**.

## A program crashes repeatedly

 **NOTE:** Software usually includes installation instructions in its documentation or on a floppy disk or CD.

**CHECK THE SOFTWARE DOCUMENTATION** — If necessary, uninstall and then reinstall the program.

## A program is designed for an earlier Windows operating system

### RUN THE PROGRAM COMPATIBILITY WIZARD —

The Program Compatibility Wizard configures a program so it runs in an environment similar to non-Windows XP operating system environments.

- 1 Click the **Start** button, point to **All Programs**→**Accessories**, and then click **Program Compatibility Wizard**.
- 2 In the welcome screen, click **Next**.
- 3 Follow the instructions on the screen.

## A solid blue screen appears

**TURN THE COMPUTER OFF** — If you are unable to get a response by pressing a key on your keyboard or moving your mouse, press and hold the power button for at least 8 to 10 seconds until the computer turns off. Then restart your computer.

## Other software problems

### **CHECK THE SOFTWARE DOCUMENTATION OR CONTACT THE SOFTWARE MANUFACTURER FOR TROUBLESHOOTING INFORMATION —**

- Ensure that the program is compatible with the operating system installed on your computer.
- Ensure that your computer meets the minimum hardware requirements needed to run the software. See the software documentation for information.
- Ensure that the program is installed and configured properly.
- Verify that the device drivers do not conflict with the program.
- If necessary, uninstall and then reinstall the program.

### **BACK UP YOUR FILES IMMEDIATELY**

### **USE A VIRUS-SCANNING PROGRAM TO CHECK THE HARD DRIVE, FLOPPY DISKS, OR CDs**

### **SAVE AND CLOSE ANY OPEN FILES OR PROGRAMS AND SHUT DOWN YOUR COMPUTER THROUGH THE START MENU**

## Memory Problems



**CAUTION:** Before you begin any of the procedures in this section, follow the safety instructions located in the *Product Information Guide*.

### **IF YOU RECEIVE AN INSUFFICIENT MEMORY MESSAGE —**

- Save and close any open files and exit any open programs you are not using to see if that resolves the problem.
- See the software documentation for minimum memory requirements. If necessary, install additional memory (see page 55).
- Reseat the memory modules to ensure that your computer is successfully communicating with the memory (see page 55).
- Run the Dell Diagnostics (see page 38).

#### **IF YOU EXPERIENCE OTHER MEMORY PROBLEMS —**

- Reseat the memory modules (see page 55) to ensure that your computer is successfully communicating with the memory.
- Ensure that you are following the memory installation guidelines (see page 55).
- Your Dell Dimension™ computer supports DDR memory. For additional information on the type of memory supported by your computer, see "Memory" on page 79.
- Run the Dell Diagnostics (see page 38).

## **Mouse Problems**



**CAUTION:** Before you begin any of the procedures in this section, follow the safety instructions located in the *Product Information Guide*.

**CLEAN THE MOUSE —** See "Cleaning Your Computer" on page 91 for instructions on cleaning the mouse.

#### **CHECK THE MOUSE CABLE —**

- 1 Check the cable connector for bent or broken pins and for damaged or frayed cables. Straighten bent pins.
- 2 Remove mouse extension cables, if used, and connect the mouse directly to the computer.
- 3 Shut down the computer (see page 47), reconnect the mouse cable as shown on the setup diagram for your computer, and then restart the computer.

#### **RESTART THE COMPUTER —**

- 1 Simultaneously press <Ctrl><Esc> to display the **Start** menu.
- 2 Type u, press the keyboard arrow keys to highlight **Shut down** or **Turn Off**, and then press <Enter>.
- 3 After the computer turns off, reconnect the mouse cable as shown on the on the setup diagram for your computer.
- 4 Start the computer.

**TEST THE MOUSE —** Connect a properly working mouse to the computer, and try using the mouse.

#### **CHECK THE MOUSE SETTINGS —**

- 1 Click the **Start** button, click **Control Panel**, and then click **Printers and Other Hardware**.
- 2 Click **Mouse**.
- 3 Try adjusting the settings.

**REINSTALL THE MOUSE DRIVER** — See page 40.

**RUN THE HARDWARE TROUBLESHOOTER** — See page 46.

## Network Problems

 **CAUTION:** Before you begin any of the procedures in this section, follow the safety instructions located in the *Product Information Guide*.

**CHECK THE NETWORK CABLE CONNECTOR** — Ensure that the network cable is firmly inserted into both the network connector on the back of the computer and the network jack.

**CHECK THE NETWORK LIGHTS ON THE BACK OF THE COMPUTER** — If the link integrity light is off, that indicates no network communication exists. Replace the network cable. For a description of network lights, see "Controls and Lights" on page 81.

**RESTART THE COMPUTER AND LOG ON TO THE NETWORK AGAIN**

**CHECK YOUR NETWORK SETTINGS** — Contact your network administrator or the person who set up your network to verify that your network settings are correct and that the network is functioning.

**RUN THE HARDWARE TROUBLESHOOTER** — See page 46.

## Power Problems

 **CAUTION:** Before you begin any of the procedures in this section, follow the safety instructions located in the *Product Information Guide*.

**IF THE POWER LIGHT IS GREEN AND THE COMPUTER IS NOT RESPONDING** — See "Diagnostic Lights" on page 35.

**IF THE POWER LIGHT IS BLINKING GREEN** — The computer is in standby mode. Press a key on the keyboard, move the mouse, or press the power button to resume normal operation.

**IF THE POWER LIGHT IS OFF** — The computer is either turned off or is not receiving power.

- Reseat the power cable into both the power connector on the back of the computer and the electrical outlet.
- If the computer is plugged into a power strip, ensure that the power strip is plugged into an electrical outlet and that the power strip is turned on. Also bypass power protection devices, power strips, and power extension cables to verify that the computer turns on properly.
- Ensure that the electrical outlet is working by testing it with another device, such as a lamp.
- Ensure that the main power cable and front panel cable are securely connected to the system board (see page 54).

**IF THE POWER LIGHT IS BLINKING AMBER** — The computer is receiving electrical power, but an internal power problem might exist.

- Ensure that the voltage selection switch (see page 50) is set to match the AC power at your location (if applicable).
- Ensure that the processor power cable (see page 54) is securely connected to the system board.

**IF THE POWER LIGHT IS STEADY AMBER** — A device might be malfunctioning or incorrectly installed.

- Remove and then reinstall the memory modules (see page 55).
- Remove and then reinstall any cards (see page 58).
- Remove and then reinstall the graphics card, if applicable (see page 58).

**ELIMINATE INTERFERENCE** — Some possible causes of interference are:

- Power, keyboard, and mouse extension cables
- Too many devices on a power strip
- Multiple power strips connected to the same electrical outlet

## Printer Problems

 **CAUTION:** Before you begin any of the procedures in this section, follow the safety instructions located in the *Product Information Guide*.

 **NOTE:** If you need technical assistance for your printer, contact the printer's manufacturer.

**CHECK THE PRINTER DOCUMENTATION** — See the printer documentation for setup and troubleshooting information.

**ENSURE THAT THE PRINTER IS TURNED ON**

#### **CHECK THE PRINTER CABLE CONNECTIONS —**

- See the printer documentation for cable connection information.
- Ensure that the printer cables are securely connected to the printer and the computer (see page 9).

**TEST THE ELECTRICAL OUTLET —** Ensure that the electrical outlet is working by testing it with another device, such as a lamp.

#### **VERIFY THAT THE PRINTER IS RECOGNIZED BY WINDOWS —**

- 1 Click the **Start** button, click **Control Panel**, and then click **Printers and Other Hardware**.
- 2 Click **View installed printers or fax printers**.  
If the printer is listed, right-click the printer icon.
- 3 Click **Properties** and click the **Ports** tab. For a parallel printer, ensure that the **Print to the following port(s)**: setting is **LPT1 (Printer Port)**. For a USB printer, ensure that the **Print to the following port(s)**: setting is **USB**.

**REINSTALL THE PRINTER DRIVER —** See the printer documentation for instructions.

## Scanner Problems



**CAUTION:** Before you begin any of the procedures in this section, follow the safety instructions located in the *Product Information Guide*.



**NOTE:** If you need technical assistance for your scanner, contact the scanner's manufacturer.

**CHECK THE SCANNER DOCUMENTATION —** See the scanner documentation for setup and troubleshooting information.

**UNLOCK THE SCANNER —** Ensure that your scanner is unlocked if it has a locking tab or button.

**RESTART THE COMPUTER AND TRY THE SCANNER AGAIN**

#### **CHECK THE CABLE CONNECTIONS —**

- See the scanner documentation for cable connection information.
- Ensure that the scanner cables are securely connected to the scanner and the computer.

**VERIFY THAT THE SCANNER IS RECOGNIZED BY MICROSOFT WINDOWS —**

1 Click the Start button, click Control Panel, and then click Printers and Other Hardware.

2 Click Scanners and Cameras.

If your scanner is listed, Windows recognizes the scanner.

**REINSTALL THE SCANNER DRIVER —** See the scanner documentation for instructions.

## Sound and Speaker Problems



**CAUTION:** Before you begin any of the procedures in this section, follow the safety instructions located in the *Product Information Guide*.

### No sound from speakers



**NOTE:** The volume control in some MP3 players overrides the Windows volume setting. If you have been listening to MP3 songs, ensure that you did not turn the player volume down or off.



**NOTE:** If you have installed a PCI audio card, the internal speaker is disabled.

**CHECK THE SPEAKER CABLE CONNECTIONS —** Ensure that the speakers are connected as shown on the setup diagram supplied with the speakers. If you purchased a sound card, ensure that the speakers are connected to the card.

**ENSURE THAT THE SUBWOOFER AND THE SPEAKERS ARE TURNED ON —** See the setup diagram supplied with the speakers. If your speakers have volume controls, adjust the volume, bass, or treble to eliminate distortion.

**ADJUST THE WINDOWS VOLUME CONTROL —** Click or double-click the speaker icon in the lower-right corner of your screen. Ensure that the volume is turned up and that the sound is not muted.

**DISCONNECT HEADPHONES FROM THE HEADPHONE CONNECTOR —** Sound from the speakers is automatically disabled when headphones are connected to the computer's front-panel headphone connector.

**TEST THE ELECTRICAL OUTLET —** Ensure that the electrical outlet is working by testing it with another device, such as a lamp.

**ELIMINATE POSSIBLE INTERFERENCE —** Turn off nearby fans, fluorescent lights, or halogen lamps to check for interference.

#### **RUN THE SPEAKER DIAGNOSTICS**

**REINSTALL THE SOUND DRIVER** — See page 40.

**RUN THE HARDWARE TROUBLESHOOTER** — See page 46.

### **No sound from headphones**

**CHECK THE HEADPHONE CABLE CONNECTION** — Ensure that the headphone cable is securely inserted into the headphone connector (see page 49).

**ADJUST THE WINDOWS VOLUME CONTROL** — Click or double-click the speaker icon in the lower-right corner of your screen. Ensure that the volume is turned up and that the sound is not muted.

## **Video and Monitor Problems**



**CAUTION:** Before you begin any of the procedures in this section, follow the safety instructions located in the *Product Information Guide*.



**NOTE:** See the monitor documentation for troubleshooting procedures.

### **If the screen is blank**

#### **CHECK THE MONITOR CABLE CONNECTION** —

- Ensure that the graphics cable is connected as shown on the setup diagram for your computer.
- If you are using a graphics extension cable and removing the cable solves the problem, the cable is defective.
- Swap the computer and monitor power cables to determine if the power cable is defective.
- Check the connector for bent or broken pins. (It is normal for monitor cable connectors to have missing pins.)

**CHECK THE MONITOR POWER LIGHT** — If the power light is off, firmly press the button to ensure that the monitor is turned on. If the power light is lit or blinking, the monitor has power. If the power light is blinking, press a key on the keyboard or move the mouse.

**TEST THE ELECTRICAL OUTLET** — Ensure that the electrical outlet is working by testing it with another device, such as a lamp.



**CHECK THE DIAGNOSTIC LIGHTS** — See page 35.

**RUN THE DELL DIAGNOSTICS** — See page 38.

## **If the screen is difficult to read**

**CHECK THE MONITOR SETTINGS** — See the monitor documentation for instructions on adjusting the contrast and brightness, demagnetizing (degaussing) the monitor, and running the monitor self-test.

**MOVE THE SUBWOOFER AWAY FROM THE MONITOR** — If your speaker system includes a subwoofer, ensure that the subwoofer is at least 60 cm (2 ft) away from the monitor.

**MOVE THE MONITOR AWAY FROM EXTERNAL POWER SOURCES** — Fans, fluorescent lights, halogen lamps, and other electrical devices can cause the screen image to appear "shaky." Turn off nearby devices to check for interference.

### **ROTATE THE MONITOR TO ELIMINATE SUNLIGHT GLARE AND POSSIBLE INTERFERENCE**

#### **ADJUST THE WINDOWS DISPLAY SETTINGS** —

- 1** Click the **Start** button, click **Control Panel**, and then click **Appearance and Themes**.
- 2** Click **Display** and click the **Settings** tab.
- 3** Try different settings for **Screen resolution** and **Color quality**.





# Advanced Troubleshooting

## Diagnostic Lights

**⚠ CAUTION:** Before you begin any of the procedures in this section, follow the safety instructions located in the *Product Information Guide*.





To help you troubleshoot a problem, your computer has four lights labeled "A," "B," "C," and "D" on the back panel (see page 50). The lights can be yellow or green. When the computer starts normally, the lights flash. After the computer starts, all four lights display solid green. If the computer malfunctions, the color and sequence of the lights identify the problem.



Light Pattern	Problem Description	Suggested Resolution
 A B C D	The computer is in a normal off condition or a possible pre-BIOS failure has occurred.	Plug the computer into a working electrical outlet and press the power button.
 A B C D	Memory modules are detected, but a memory failure has occurred.	<ul style="list-style-type: none"> <li>• If you have one memory module installed, reinstall it (see page 55) and restart the computer.</li> <li>• If you have two or more memory modules installed, remove the modules, reinstall one module (see page 55), and then restart the computer. If the computer starts normally, reinstall an additional module. Continue until you have identified a faulty module or reinstalled all modules without error.</li> <li>• If available, install properly working memory of the same type into your computer (see page 55).</li> <li>• If the problem persists, contact Dell (see page 94).</li> </ul>



 = yellow



 = green

 = off



Light Pattern	Problem Description	Suggested Resolution
 <p>A B C D</p>	<p>A possible graphics card failure has occurred.</p>	<ul style="list-style-type: none"> <li>• If the computer has a graphics card, remove the card, reinstall it (see page 58), and then restart the computer.</li> <li>• If the problem still exists, install a graphics card that you know works and restart the computer.</li> <li>• If the problem persists or the computer has integrated graphics, contact Dell (see page 94).</li> </ul>
 <p>A B C D</p>	<p>A possible floppy or hard drive failure has occurred.</p>	<p>Reseat all power and data cables and restart the computer.</p>
 <p>A B C D</p>	<p>A possible USB failure has occurred.</p>	<p>Reinstall all USB devices, check cable connections, and then restart the computer.</p>
 <p>A B C D</p>	<p>Memory modules are detected, but a memory configuration or compatibility error exists.</p>	<ul style="list-style-type: none"> <li>• Ensure that no special memory module/memory connector placement requirements exist (see page 55).</li> <li>• Verify that the memory modules that you are installing are compatible with your computer (see page 55).</li> <li>• If the problem persists, contact Dell (see page 94).</li> </ul>

-  = yellow
-  = green
-  = off

Light Pattern	Problem Description	Suggested Resolution
 <p>A B C D</p>	<p>A possible expansion card failure has occurred.</p>	<ol style="list-style-type: none"> <li><b>1</b> Determine if a conflict exists by removing a card (not a graphics card) and restarting the computer (see page 58).</li> <li><b>2</b> If the problem persists, reinstall the card that you removed, remove a different card, and then restart the computer.</li> <li><b>3</b> Repeat this process for each card. If the computer starts normally, troubleshoot the last card removed from the computer for resource conflicts (see "Resolving Software and Hardware Incompatibilities" on page 46).</li> <li><b>4</b> If the problem persists, contact Dell (see page 94).</li> </ol>
 <p>A B C D</p>	<p>Another failure has occurred.</p>	<ul style="list-style-type: none"> <li>• Ensure that the cables are properly connected to the system board from the hard drive, CD drive, and DVD drive (see page 54).</li> <li>• If there is an error message on your screen identifying a problem with a device (such as the floppy drive or hard drive), check the device to make sure it is functioning properly.</li> <li>• The operating system is attempting to boot from a device (such as the floppy drive or hard drive); check system setup (see page 82) to make sure that the boot sequence is correct for the devices installed on your computer.</li> <li>• If the problem persists, contact Dell (see page 94).</li> </ul>

-  = yellow
-  = green
-  = off

Light Pattern	Problem Description	Suggested Resolution
 A B C D	The computer is in a normal operating condition after POST.	None.

-  = yellow
-  = green
-  = off

## Dell Diagnostics

**CAUTION:** Before you begin any of the procedures in this section, follow the safety instructions located in the *Product Information Guide*.

If you experience a problem with your computer, perform the checks in "Solving Problems" on page 19 and run the Dell Diagnostics before you contact Dell for technical assistance.

**NOTICE:** The Dell Diagnostics works only on Dell™ computers.

- 1 Turn on (or restart) your computer.
- 2 When the DELL™ logo appears, press <F12> immediately.  
If you wait too long and the operating system logo appears, continue to wait until you see the Microsoft® Windows® desktop. Then shut down your computer (see page 47) and try again.
- 3 When the boot device list appears, highlight **Boot to Utility Partition** and press <Enter>.
- 4 When the Dell Diagnostics **Main Menu** appears, select the test you want to run (see page 38).

### Dell Diagnostics Main Menu

- 1 After the Dell Diagnostics loads and the **Main Menu** screen appears, click the button for the option you want.

Option	Function
Express Test	Performs a quick test of devices. This test typically takes 10 to 20 minutes and requires no interaction on your part. Run <b>Express Test</b> first to increase the possibility of tracing the problem quickly.
Extended Test	Performs a thorough check of devices. This test typically takes an hour or more and requires you to answer questions periodically.

<b>Option</b>	<b>Function</b>
Custom Test	Tests a specific device. You can customize the tests you want to run.
Symptom Tree	Lists the most common symptoms encountered and allows you to select a test based on the symptom of the problem you are having.

- 2 If a problem is encountered during a test, a message appears with an error code and a description of the problem. Write down the error code and problem description and follow the instructions on the screen.

If you cannot resolve the error condition, contact Dell (see page 94).



**NOTE:** The Service Tag for your computer is located at the top of each test screen. If you contact Dell, technical support will ask for your Service Tag.

- 3 If you run a test from the **Custom Test** or **Symptom Tree** option, click the applicable tab described in the following table for more information.

<b>Tab</b>	<b>Function</b>
Results	Displays the results of the test and any error conditions encountered.
Errors	Displays error conditions encountered, error codes, and the problem description.
Help	Describes the test and may indicate requirements for running the test.
Configuration	Displays your hardware configuration for the selected device. The Dell Diagnostics obtains configuration information for all devices from system setup, memory, and various internal tests, and it displays the information in the device list in the left pane of the screen. The device list may not display the names of all the components installed on your computer or all devices attached to your computer.
Parameters	Allows you to customize the test by changing the test settings.

- 4 Close the test screen to return to the **Main Menu** screen. To exit the Dell Diagnostics and restart the computer, close the **Main Menu** screen.

# Drivers

## What Is a Driver?

A driver is a program that controls a device such as a printer, mouse, or keyboard. All devices require a driver program.

A driver acts like a translator between the device and any other programs that use the device. Each device has its own set of specialized commands that only its driver recognizes.

Dell ships your computer to you with required drivers already installed—no further installation or configuration is needed.

Many drivers, such as the keyboard driver, come with your Microsoft® Windows® operating system. You may need to install drivers if you:

- Upgrade your operating system.
- Reinstall your operating system.
- Connect or install a new device.

## Identifying Drivers

If you experience a problem with any device, identify whether the driver is the source of your problem and, if necessary, update the driver.

- 1 Click the **Start** button and click **Control Panel**.
- 2 Under **Pick a Category**, click **Performance and Maintenance**.
- 3 Click **System**.
- 4 In the **System Properties** window, click the **Hardware** tab.
- 5 Click **Device Manager**.
- 6 Scroll down the list to see if any device has an exclamation point (a yellow circle with a [!]) on the device icon.

If an exclamation point is next to the device name, you may need to reinstall the driver or install a new driver.

## Reinstalling Drivers



**NOTICE:** The Dell Support website at [support.dell.com](http://support.dell.com) provides approved drivers for Dell™ computers. If you install drivers obtained from other sources, your computer might not work correctly.



### Using Windows XP Device Driver Rollback

If a problem occurs on your computer after you install or update a driver, use Windows XP Device Driver Rollback to replace the driver with the previously installed version.

- 1 Click the **Start** button and click **Control Panel**.
- 2 Under **Pick a Category**, click **Performance and Maintenance**.
- 3 Click **System**.
- 4 In the **System Properties** window, click the **Hardware** tab.
- 5 Click **Device Manager**.
- 6 Right-click the device for which the new driver was installed and click **Properties**.
- 7 Click the **Drivers** tab.
- 8 Click **Roll Back Driver**.

If Device Driver Rollback does not resolve the problem, then use System Restore to return your computer to the operating state that existed before you installed the new driver.

### Manually Reinstalling Drivers

- 1 After copying the required driver files to your hard drive, click the **Start** button and right-click **My Computer**.
- 2 Click **Properties**.
- 3 Click the **Hardware** tab and click **Device Manager**.
- 4 Double-click the type of device for which you are installing the driver.
- 5 Double-click the name of the device for which you are installing the driver.
- 6 Click the **Driver** tab and click **Update Driver**.
- 7 Click **Install from a list or specific location (Advanced)** and click **Next**.
- 8 Click **Browse** and browse to the location to which you previously extracted the driver files.
- 9 When the name of the appropriate driver appears, click **Next**.
- 10 Click **Finish** and restart your computer.

## Restoring Your Operating System

You can restore your operating system in the following ways:

- Microsoft® Windows® XP System Restore returns your computer to an earlier operating state without affecting data files. Use System Restore as the first solution for restoring your operating system and preserving data files.

- Dell PC Restore by Symantec restores your hard drive to the operating state it was in when you purchased the computer. Dell PC Restore permanently deletes all data on the hard drive and removes any applications installed after you received the computer. Use PC Restore only if System Restore did not resolve your operating system problem.

If you received an *Operating System* CD with your computer, you can use it to restore your operating system. However, using the *Operating System* CD also deletes all data on the hard drive. Use the CD *only* if System Restore did not resolve your operating system problem.

## Using Microsoft Windows XP System Restore

The Microsoft Windows XP operating system provides System Restore to allow you to return your computer to an earlier operating state (without affecting data files) if changes to the hardware, software, or other system settings have left the computer in an undesirable operating state. See the Windows Help and Support Center for information on using System Restore. To access the Windows Help and Support Center, see *Windows Help and Support Center*.



**NOTICE:** Make regular backups of your data files. System Restore does not monitor your data files or recover them.



**NOTE:** The procedures in this document were written for the Windows default view, so they may not apply if you set your Dell™ computer to the Windows Classic view.

### Creating a Restore Point

- 1 Click the **Start** button and click **Help and Support**.
- 2 Click the task for **System Restore**.
- 3 Follow the instructions on the screen.

### Restoring the Computer to an Earlier Operating State

If problems occur after you install a device driver, use Device Driver Rollback (see page 41) to resolve the problem. If that is unsuccessful, then use System Restore.



**NOTICE:** Before you restore the computer to an earlier operating state, save and close any open files and exit any open programs. Do not alter, open, or delete any files or programs until the system restoration is complete.

- 1 Click the **Start** button, point to **All Programs**→**Accessories**→**System Tools**, and then click **System Restore**.
- 2 Ensure that **Restore my computer to an earlier time** is selected and click **Next**.
- 3 Click a calendar date to which you want to restore your computer.

The **Select a Restore Point** screen provides a calendar that allows you to see and select restore points. All calendar dates with available restore points appear in boldface type.

- 4 Select a restore point and click **Next**.

If a calendar date has only one restore point, then that restore point is automatically selected. If two or more restore points are available, click the restore point that you prefer.

- 5 Click **Next**.

The **Restoration Complete** screen appears after System Restore finishes collecting data and then the computer restarts.

- 6 After the computer restarts, click **OK**.

To change the restore point, you can either repeat the steps using a different restore point, or you can undo the restoration.

### Undoing the Last System Restore



**NOTICE:** Before you undo the last system restore, save and close all open files and exit any open programs. Do not alter, open, or delete any files or programs until the system restoration is complete.

- 1 Click the **Start** button, point to **All Programs**→**Accessories**→**System Tools**, and then click **System Restore**.
- 2 Click **Undo my last restoration** and click **Next**.

### Enabling System Restore

If you reinstall Windows XP with less than 200 MB of free hard-disk space available, System Restore is automatically disabled. To see if System Restore is enabled:

- 1 Click the **Start** button and click **Control Panel**.
- 2 Click **Performance and Maintenance**.
- 3 Click **System**.
- 4 Click the **System Restore** tab.

Ensure that **Turn off System Restore** is unchecked.

### Using Dell PC Restore by Symantec



**NOTICE:** Using Dell PC Restore permanently deletes all data on the hard drive and removes any applications or drivers installed after you received your computer. If possible, back up the data before using PC Restore. Use PC Restore only if System Restore did not resolve your operating system problem.



**NOTE:** Dell PC Restore by Symantec is not available in all countries or on all computers.

Use Dell PC Restore by Symantec only as the last method to restore your operating system. PC Restore restores your hard drive to the operating state it was in when you purchased the computer. Any programs or files added since you received your computer—including data files—are permanently deleted from the hard drive. Data files include documents, spreadsheets, e-mail messages, digital photos, music files, and so on. If possible, back up all data before using PC Restore.

To use PC Restore:

- 1 Turn on the computer.

During the boot process, a blue bar with [www.dell.com](http://www.dell.com) appears at the top of the screen.

- 2 Immediately upon seeing the blue bar, press <Ctrl><F11>.

If you do not press <Ctrl><F11> in time, let the computer finish starting, and then restart the computer again.

 **NOTICE:** If you do not want to proceed with PC Restore, click **Reboot** in the following step.

- 3 On the next screen that appears, click **Restore**.

- 4 On the next screen, click **Confirm**.

The restore process takes approximately 6–10 minutes to complete.

- 5 When prompted, click **Finish** to reboot the computer.

 **NOTE:** Do not manually shut down the computer. Click **Finish** and let the computer completely reboot.

- 6 When prompted, click **Yes**.

The computer restarts. Because the computer is restored to its original operating state, the screens that appear, such as the End User License Agreement, are the same ones that appeared the first time the computer was turned on.

- 7 Click **Next**.

The **System Restore** screen appears and the computer restarts.

- 8 After the computer restarts, click **OK**.

## Removing Dell PC Restore

 **NOTICE:** Removing Dell PC Restore from the hard drive permanently deletes the PC Restore utility from your computer. After you have removed Dell PC Restore, you will not be able to use it to restore your computer's operating system.

Dell PC Restore enables you to restore your hard drive to the operating state it was in when you purchased your computer. It is recommended that you *do not* remove PC Restore from your computer, even to gain additional hard-drive space. If you remove PC Restore from the hard drive, you cannot ever recall it, and you will never be able to use PC Restore to return your computer's operating system to its original state.

To remove PC Restore:

- 1 Log on to the computer as a local administrator.
- 2 In Windows Explorer, go to `c:\dell\utilities\DSR`.
- 3 Double-click the filename `DSRIRRemv2.exe`.

 **NOTE:** If you do not log on as a local administrator, a message appears stating that you must log on as administrator. Click **Quit**, and then log on as a local administrator.

 **NOTE:** If the partition for PC Restore does not exist on your computer's hard drive, a message appears stating that the partition was not found. Click **Quit**; there is no partition to delete.

- 4 Click **OK** to remove the PC Restore partition on the hard drive.
- 5 Click **Yes** when a confirmation message appears.  
The PC Restore partition is deleted and the newly available disk space is added to the free space allocation on the hard drive.
- 6 Right-click **Local Disk (C)** in Windows Explorer, click **Properties**, and verify that the additional disk space is available as indicated by the increased value for **Free Space**.
- 7 Click **Finish** to close the **PC Restore Removal** window.
- 8 Restart the computer.

## Using the Operating System CD

### Before You Begin

If you are considering reinstalling the Windows XP operating system to correct a problem with a newly installed driver, first try using Windows XP Device Driver Rollback. See [Using Windows XP Device Driver Rollback](#). If Device Driver Rollback does not resolve the problem, then use System Restore to return your operating system to the operating state it was in before you installed the new device driver. See [Using Microsoft Windows XP System Restore](#).

 **NOTICE:** Before performing the installation, back up all data files on your primary hard drive. For conventional hard drive configurations, the primary hard drive is the first drive detected by the computer.

To reinstall Windows XP, you need the following items:

- Dell™ *Operating System* CD
- Dell ResourceCD

 **NOTE:** The ResourceCD contains drivers that were installed during assembly of the computer. Use the ResourceCD to load any required drivers. Depending on the region from where you ordered your computer, or whether you requested the CDs, the *Drivers and Utilities* CD and *Operating System* CD may not ship with your system.

### Reinstalling Windows XP

The reinstallation process can take 1 to 2 hours to complete. After you reinstall the operating system, you must also reinstall the device drivers, virus protection program, and other software.

 **NOTICE:** The *Operating System* CD provides options for reinstalling Windows XP. The options can overwrite files and possibly affect programs installed on your hard drive. Therefore, do not reinstall Windows XP unless a Dell technical support representative instructs you to do so.

- 1 Save and close any open files and exit any open programs.
- 2 Insert the *Operating System* CD. Click **Exit** if the **Install Windows XP** message appears.
- 3 Restart the computer.

- 4 Press <F12> immediately after the DELL™ logo appears.

If the operating system logo appears, wait until you see the Windows desktop, and then shut down the computer and try again.

Follow the instructions on the screen to complete the installation.

## Resolving Software and Hardware Incompatibilities

If a device is either not detected during the operating system setup or is detected but incorrectly configured, you can use the Hardware Troubleshooter to resolve the incompatibility.

To resolve incompatibilities using the Hardware Troubleshooter:

- 1 Click the **Start** button and click **Help and Support**.
- 2 Type `hardware troubleshooter` in the **Search** field and click the arrow to start the search.
- 3 Click **Hardware Troubleshooter** in the **Search Results** list.
- 4 In the **Hardware Troubleshooter** list, click **I need to resolve a hardware conflict on my computer**, and click **Next**.

# Removing and Installing Parts

## Before You Begin

This chapter provides procedures for removing and installing the components in your computer. Unless otherwise noted, each procedure assumes that the following conditions exist:

- You have performed the steps in "Turning Off Your Computer" and "Before Working Inside Your Computer."
- You have read the safety information in your Dell™ *Product Information Guide*.
- A component can be replaced or—if purchased separately—installed by performing the removal procedure in reverse order.

## Recommended Tools

The procedures in this document may require the following tools:

- Small flat-blade screwdriver
- Phillips screwdriver

## Turning Off Your Computer



**NOTICE:** To avoid losing data, save and close any open files and exit any open programs before you turn off your computer.

- 1 Shut down the operating system:
  - a Save and close any open files, exit any open programs, click the **Start** button, and then click **Turn Off Computer**.
  - b In the **Turn off computer** window, click **Turn off**.

The computer turns off after the operating system shutdown process finishes.

- 2 Ensure that the computer and any attached devices are turned off. If your computer and attached devices did not automatically turn off when you shut down your operating system, press and hold the power button for 4 seconds.

## Before Working Inside Your Computer

Use the following safety guidelines to help protect your computer from potential damage and to help ensure your own personal safety.

 **CAUTION:** Before you begin any of the procedures in this section, follow the safety instructions located in the *Product Information Guide*.

 **CAUTION:** Handle components and cards with care. Do not touch the components or contacts on a card. Hold a card by its edges or by its metal mounting bracket. Hold a component such as a processor by its edges, not by its pins.

 **NOTICE:** Only a certified service technician should perform repairs on your computer. Damage due to servicing that is not authorized by Dell is not covered by your warranty.

 **NOTICE:** When you disconnect a cable, pull on its connector or on its strain-relief loop, not on the cable itself. Some cables have a connector with locking tabs; if you are disconnecting this type of cable, press in on the locking tabs before you disconnect the cable. As you pull connectors apart, keep them evenly aligned to avoid bending any connector pins. Also, before you connect a cable, ensure that both connectors are correctly oriented and aligned.

 **NOTICE:** To avoid damaging the computer, perform the following steps before you begin working inside the computer.

1 Turn off your computer (see page 47).

 **NOTICE:** To disconnect a network cable, first unplug the cable from your computer and then unplug it from the network wall jack.

2 Disconnect any telephone or telecommunication lines from the computer.

3 Disconnect your computer and all attached devices from their electrical outlets, and then press the power button to ground the system board.

 **CAUTION:** To guard against electrical shock, always unplug your computer from the electrical outlet before opening the cover.

4 Open the computer cover (see page 52).

 **NOTICE:** Before touching anything inside your computer, ground yourself by touching an unpainted metal surface, such as the metal at the back of the computer. While you work, periodically touch an unpainted metal surface to dissipate any static electricity that could harm internal components.



# Front and Back View of the Computer

## Front View

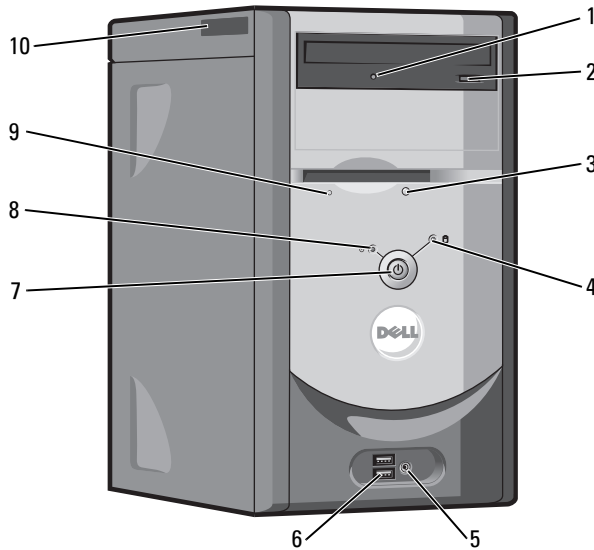

1	CD or DVD drive-activity light	The drive activity light is on when the computer reads data from the CD or DVD drive.
2	CD or DVD drive eject button	Press to eject a disc from the CD or DVD drive.
3	floppy-drive eject button	Press to eject a floppy disk from the floppy drive. (On computers with an optional floppy drive.)
4	hard-drive activity light	The light is on when the computer reads data from or writes data to the hard drive. The light might also be on when a device such as your CD player is operating.
5	headphone connector	Use the headphone connector to attach headphones and most kinds of speakers.
6	USB 2.0 connectors (2)	Use the front USB connectors for devices that you connect occasionally, such as joysticks or cameras, or for bootable USB devices (see "System Setup" on page 82 for more information on booting to a USB device).  It is recommended that you use the back USB connectors for devices that typically remain connected, such as printers and keyboards.
7	power button	Press to turn on the computer.

**➡ NOTICE:** To avoid losing data, do not use the power button to turn off the computer. Instead, perform an operating system shutdown.

8	power light	The power light illuminates and blinks or remains solid to indicate different states: <ul style="list-style-type: none"> <li>• No light — The computer is turned off.</li> <li>• Steady green — The computer is in a normal operating state.</li> <li>• Blinking green — The computer is in a power-saving state.</li> <li>• Blinking or solid amber — See "Power Problems" on page 28.</li> </ul>
9	floppy-drive activity light	The floppy drive light is on when the computer reads data from or writes data to the floppy drive. Wait until this light turns off before you remove the floppy disk from the drive. (On computers with an optional floppy drive.)
10	Service Tag	Used to identify your computer when you access the Dell Support website or call technical support.

## Back View

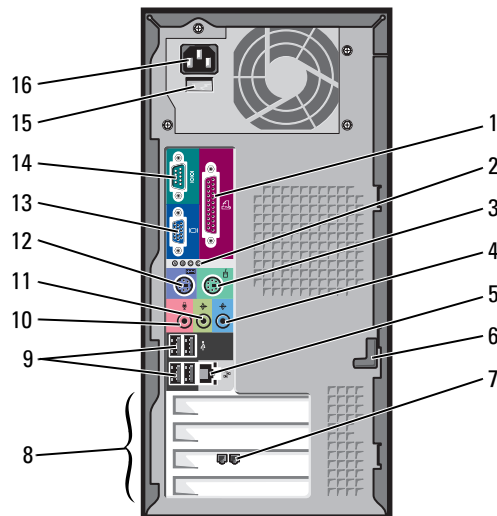

1	parallel connector	Connect a parallel device, such as a printer, to the parallel connector. If you have a USB printer, plug it into a USB connector.
2	diagnostic lights (4)	Use the lights to help you troubleshoot a computer problem based on the diagnostic code. For more information, see "Diagnostic Lights" on page 35.
3	mouse connector	Plug a standard mouse into the green mouse connector. Turn off the computer and any attached devices before you connect a mouse to the computer. If you have a USB mouse, plug it into a USB connector.

4	line-in connector	Use the blue line-in connector to attach a record/playback device such as a cassette player, CD player, or VCR. On computers with a sound card, use the connector on the card.
5	network adapter connector	To attach your computer to a network or broadband device, connect one end of a network cable to either a network jack or your network or broadband device. Connect the other end of the network cable to the network adapter connector on your computer. A click indicates that the network cable has been securely attached. <b>NOTE: Do not plug a telephone cable into the network connector.</b> On computers with a network connector card, use the connector on the card. It is recommended that you use Category 5 wiring and connectors for your network. If you must use Category 3 wiring, force the network speed to 10 Mbps to ensure reliable operation.
6	cover latch	Releases the cover from the computer. See "Removing the Computer Cover" on page 52.
7	modem connector	(Optional) If you have a modem, connect a telephone cable to either of the modem connectors. Do not connect the telephone cable to the network connector. <b>NOTE: Not all modems have two connectors.</b>
8	card slots	Access connectors for any installed PCI cards (three slots).
9	USB 2.0 connectors (4)	Use the back USB connectors for devices that typically remain connected, such as printers and keyboards. It is recommended that you use the front USB connectors for devices that you connect occasionally, such as joysticks or cameras, or for bootable USB devices.
10	microphone connector	Use the pink microphone connector to attach a personal computer microphone for voice or musical input into a sound or telephony program. On computers with a sound card, the microphone connector is on the card.
11	line-out connector	Use the green line-out connector to attach headphones and most speakers with integrated amplifiers. On computers with a sound card, use the connector on the card.
12	keyboard connector	If you have a standard keyboard, plug it into the purple keyboard connector. If you have a USB keyboard, plug it into a USB connector.
13	integrated video connector	If this connector has a protective cap over it, then your computer has the optional video card installed. If this connector does not have a protective cap over it, plug the cable from your monitor into the blue connector.
14	serial connector	Connect a serial device, such as a handheld device, to the serial port.
15	voltage selection switch	See the safety instructions located in the <i>Product Information Guide</i> for more information.
16	power connector	Insert the power cable.

## Removing the Computer Cover



**CAUTION:** Before you begin any of the procedures in this section, follow the safety instructions located in the *Product Information Guide*.



**CAUTION:** To guard against electrical shock, always unplug your computer from the electrical outlet before opening the cover.

- 1 Follow the procedures in "Before You Begin" on page 47.
- 2 Lay your computer on its side with the computer cover facing up.
- 3 If your computer cover has a cover latch, slide and hold the cover latch.
- 4 Grip the indents on the computer cover, and slide the computer cover toward the back of the computer.

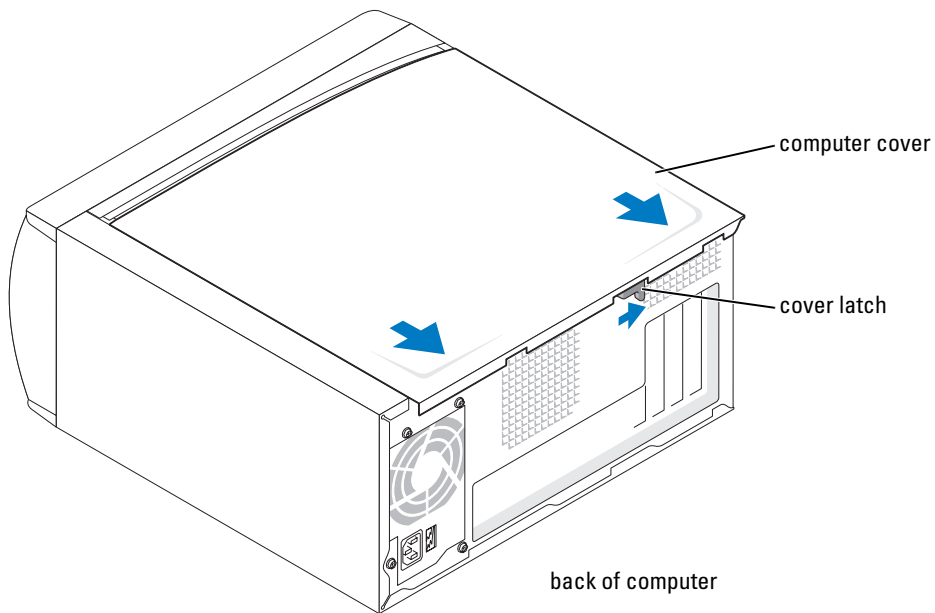

- 5 Place the computer cover on a level surface.

## Inside View of Your Computer

 **CAUTION:** Before you begin any of the procedures in this section, see the safety instructions located in the *Product Information Guide*.

 **CAUTION:** To guard against electrical shock, always unplug your computer from the electrical outlet before opening the computer cover.

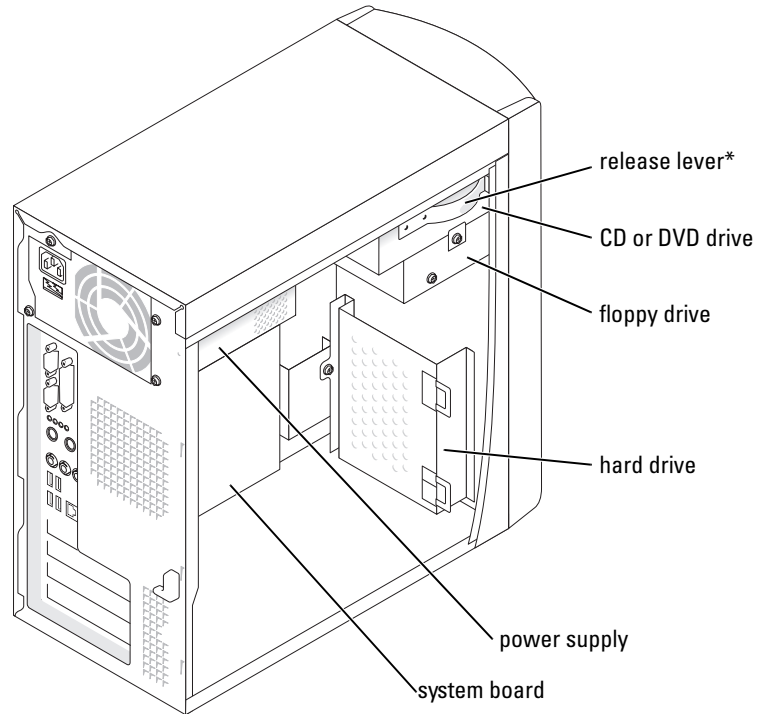

\*May not be present on all computers.



# Memory

You can increase your computer memory by installing memory modules on the system board. For information on the type of memory supported by your computer, see "Memory" on page 79.

 **NOTE:** DDR 333 memory operates at 320 MHz when used with an 800-MHz front-side bus.

## DDR Memory Overview

DDR memory modules should be installed in *pairs of matched memory size*. This means that if you purchased your computer with 128 MB of memory installed and you want to add another 128 MB of memory, you should install it in the appropriate connector. If the DDR memory modules are not installed in matched pairs, the computer will continue to operate, but with a slight reduction in performance.

 **NOTE:** Always install DDR memory modules in the order indicated on the system board.

 **NOTE:** Your computer has two memory slots labeled DIMM3 and DIMM4.

The recommended memory configurations are:

- Install a pair of matched memory modules in connectors DIMM3 and DIMM4.
- Do not install ECC memory modules.
- If you install a mixed pair PC2700 (DDR 333-MHz) and PC3200 (DDR 400-MHz) memory, the modules function at the slowest speed installed.
- Be sure to install a single memory module in DIMM3 or the connector closest to the processor before you install modules in the other connector.

## Memory Installation Guidelines

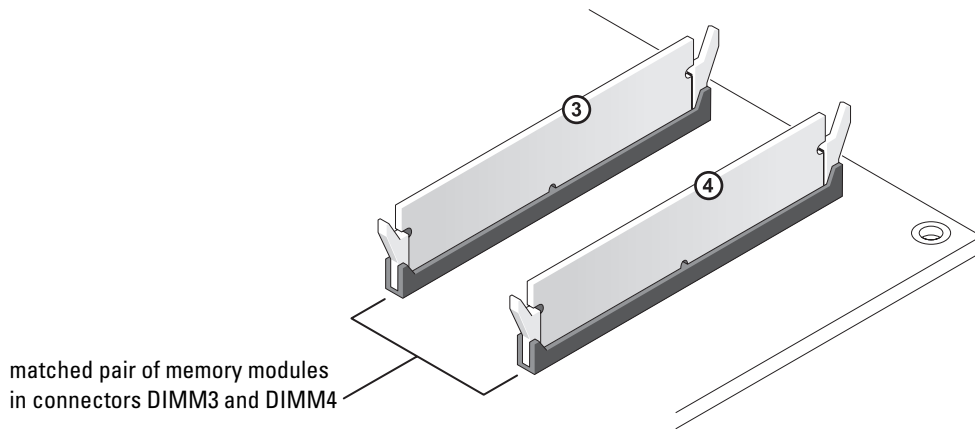

 **NOTICE:** If you remove your original memory modules from the computer during a memory upgrade, keep them separate from any new modules that you may have, even if you purchased the new modules from Dell. You should install your new memory modules in connectors DIMM3 and DIMM4. If possible, *do not* pair an original memory module with a new memory module. Otherwise, your computer may not function at optimal performance.

 **NOTE:** Memory purchased from Dell is covered under your computer warranty.

## Installing Memory

 **CAUTION:** Before you begin any of the procedures in this section, follow the safety instructions located in the *Product Information Guide*.

- 1 Shut down the computer through the **Start** menu (see page 47).
- 2 Ensure that your computer and attached devices are turned off. If your computer and attached devices did not automatically turn off when you shut down your computer, turn them off now.

 **NOTICE:** To disconnect a network cable, first unplug the cable from your computer and then unplug it from the network wall jack.

- 3 Disconnect any telephone or telecommunication lines from the computer.
- 4 Disconnect your computer and all attached devices from their electrical outlets, and then press the power button to ground the system board.

 **CAUTION:** To guard against electrical shock, always unplug your computer from the electrical outlet before opening the cover.

- 5 Remove the computer cover (see page 52).
- 6 Lay the computer on its side so that the system board is on the bottom of the inside of the computer.
- 7 If necessary, remove a memory module:
  - a Press out the securing clip at each end of the memory module connector.
  - b Grasp the module and pull up.

If the module is difficult to remove, gently ease the module back and forth to remove it from the connector.



- 8 To insert a module, press out the securing clip at each end of the memory module connector.

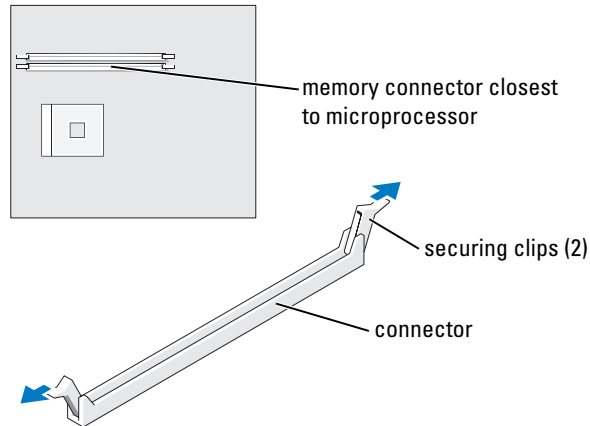

- 9 Align the notch on the bottom of the module with the crossbar in the connector.

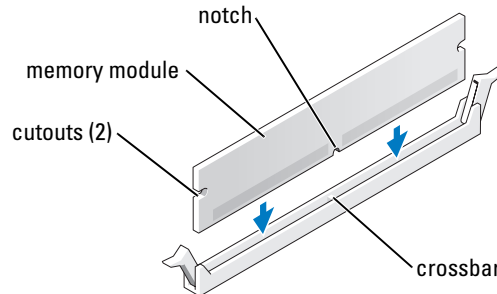

➡ **NOTICE:** To avoid breaking the memory module, do not press near the middle of the module.

- 10 Insert the module straight down into the connector, ensuring that it fits into the vertical guides at each end of the connector. Press firmly on the ends of the module until it snaps into place. If you insert the module correctly, the securing clips snap into the cutouts at each end of the module.

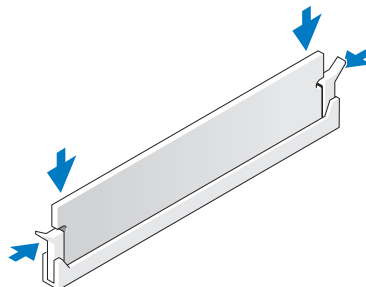

- 11 Replace the computer cover (see page 78).
- ➡ **NOTICE:** To connect a network cable, first plug the cable into the network wall jack and then plug it into the computer.
- 12 Connect your computer and devices to electrical outlets, and then turn them on.
- 13 Click the **Start** button, right-click **My Computer**, and then click **Properties**.
- 14 Click the **General** tab.
- 15 To verify that the memory is installed correctly, check the amount of memory (RAM) listed.

## Cards

⚠ **CAUTION:** Before you begin any of the procedures in this section, follow the safety instructions located in the *Product Information Guide*.

➡ **NOTICE:** To prevent static damage to components inside your computer, discharge static electricity from your body before you touch any of your computer's electronic components. You can do so by touching an unpainted metal surface on the computer chassis.

Your Dell™ computer provides three slots for PCI cards.

### PCI Cards

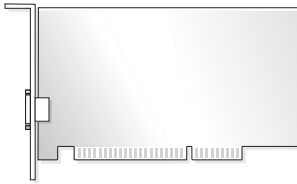

If you are installing or replacing a card, follow the procedures in the next section. If you are removing but not replacing a card, see "Removing a PCI Card" on page 60.

If you are replacing a card, remove the current driver for the card from the operating system.

#### Installing a PCI Card

- 1 Follow the procedures in "Before You Begin" on page 47.
- 2 Unscrew and remove the filler bracket for the card slot you want to use.

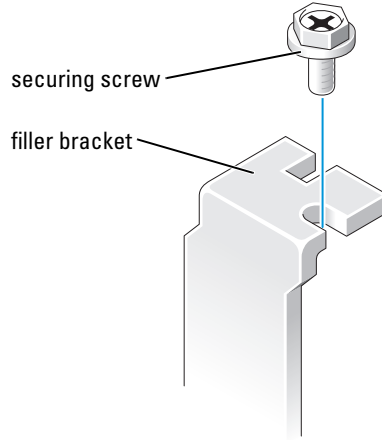

**CAUTION:** Some network adapters automatically start the computer when they are connected to a network. To guard against electrical shock, be sure to unplug your computer from its electrical outlet before installing any cards.

- 3 Align the cutout on the bottom of the card with the crossbar in the system board connector. Gently rock the card into the connector until it is fully seated.

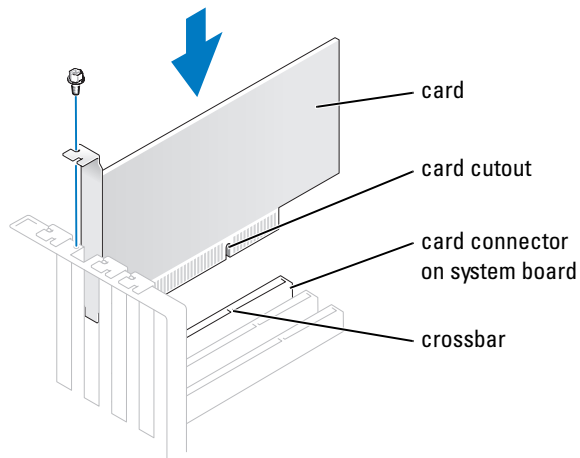

Ensure that the card is fully seated and that its bracket is within the card slot.

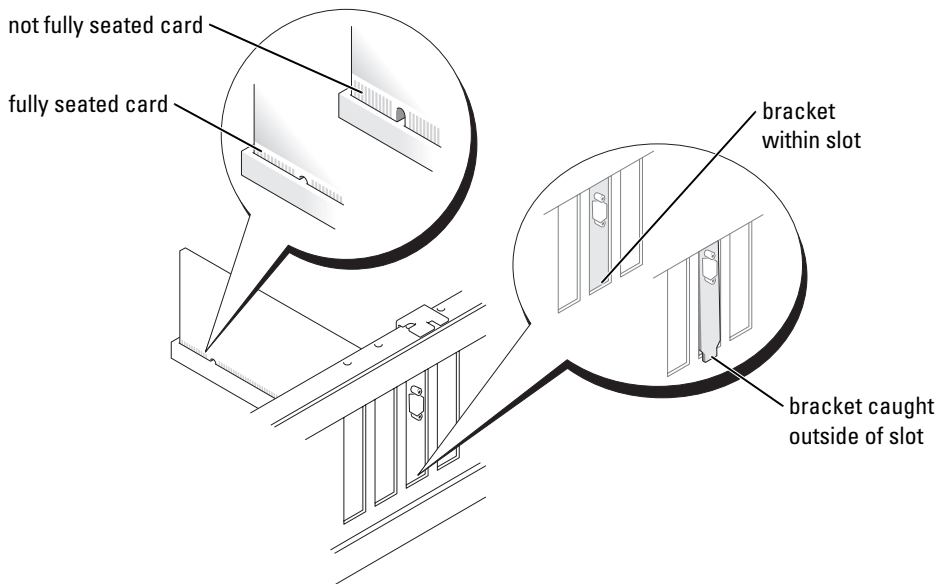

4 Secure the card bracket with the screw you removed in step 2.

5 Connect any cables that should be attached to the card.

See the documentation for the card for information about the card's cable connections.

**NOTICE:** Do not route card cables over or behind the cards. Cables routed over the cards can cause damage to the equipment.

6 If you installed a sound card:

a Enter system setup (see page 82), select **Audio Controller**, and then change the setting to **Off**.

b Connect external audio devices to the sound card's connectors. Do not connect external audio devices to the microphone, speaker/headphone, or line-in connectors on the back panel.

7 If you installed an add-in network adapter and want to disable the integrated network adapter:

a Enter system setup (see page 82), select **Network Controller**, and then change the setting to **Off**.

b Connect the network cable to the add-in network adapter's connectors. Do not connect the network cable to the integrated connector on the back panel.

8 Install any drivers required for the card as described in the card documentation.

### Removing a PCI Card

1 Follow the procedures in "Before You Begin" on page 47.

2 If necessary, disconnect any cables connected to the card.

- 3 Remove the securing screw from the card bracket.
- 4 Grasp the card by its top corners, and ease it out of its connector.
- 5 If you are removing the card permanently, install a filler bracket in the empty card-slot opening. If you need a filler bracket, contact Dell (see page 94).

 **NOTE:** Installing filler brackets over empty card-slot openings is necessary to maintain FCC certification of the computer. The brackets also keep dust and dirt out of your computer.

 **NOTICE:** To connect a network cable, first plug the cable into the network wall jack and then plug it into the computer.

- 6 Close the computer cover, reconnect the computer and devices to electrical outlets, and then turn them on.
- 7 Remove the card's driver from the operating system.
- 8 If you removed a sound card:
  - a Enter system setup (see page 82), select **Audio Controller**, and then change the setting to **On**.
  - b Connect external audio devices to the audio connectors on the computer back panel.
- 9 If you removed an add-in network connector:
  - a Enter system setup (see page 82), select **Network Controller**, and then change the setting to **On**.
  - b Connect the network cable to the integrated connector on the computer back panel.

## Front Panel



**CAUTION:** Before you begin any of the procedures in this section, follow the safety instructions located in the *Product Information Guide*.



**CAUTION:** To guard against electrical shock, always unplug your computer from the electrical outlet before opening the cover.

## Removing the Front Panel

- 1 Follow the procedures in "Before You Begin" on page 47.
- 2 Remove the computer cover (see page 52).
- 3 Release and remove the front panel:
  - a If your computer has a release lever, push the release lever to release the top tab.
  - b Reach inside the computer and push the top and bottom tab towards you to release them.
  - c Rotate the front panel to separate it from the side hinges.

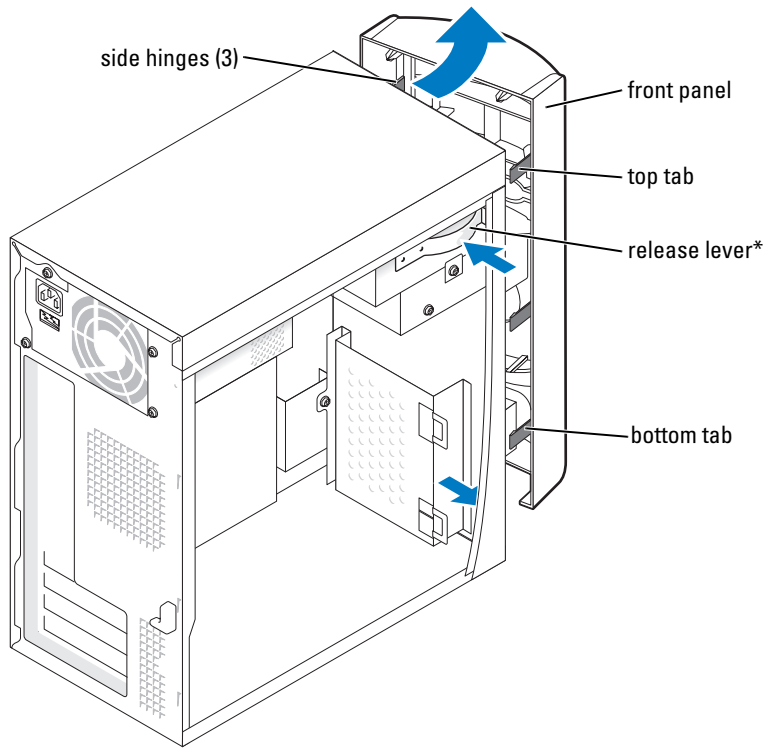

\*May not be present on all computers.

## Removing the Front-Panel Insert

- 1 Press in the two insert tabs.

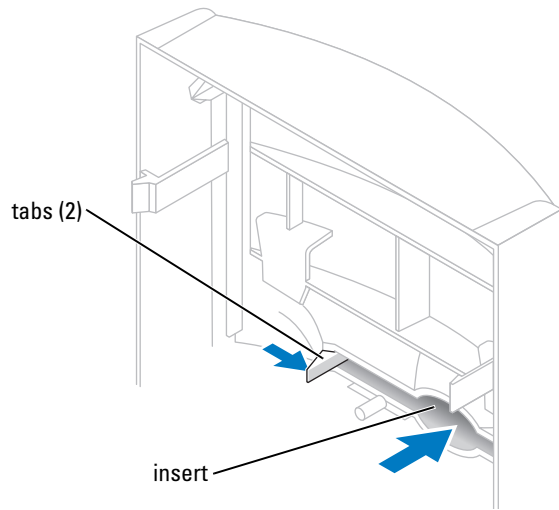

- 2 Push out the front-panel insert.

## Reattaching the Front Panel

- 1 Reattach the front panel to the side hinges.

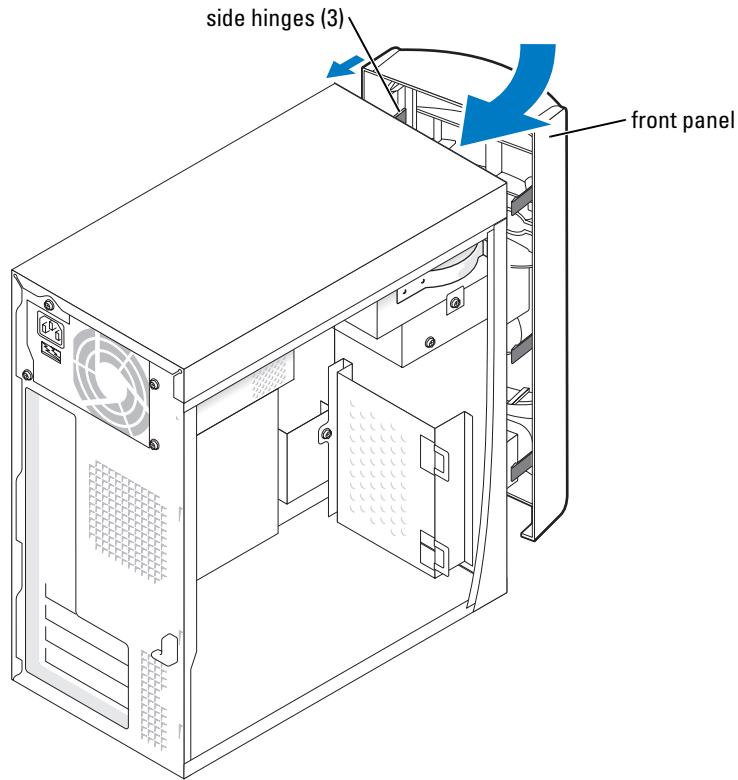

- 2 Rotate the front panel until it snaps onto the front of the computer.

## Drives

Your computer supports a combination of these devices:

- One hard drive
- One optional floppy
- Up to two CD or DVD drives



## General Installation Guidelines

Connect the IDE hard drive to the system board connector labeled PRI IDE. Connect CD/DVD drives to the connector labeled J6J1.

When you connect two IDE devices to a single IDE interface cable and configure them for the cable select setting, the device attached to the last connector on the interface cable is primary or the boot device (drive 0), and the device attached to the middle connector on the interface cable is the secondary device (drive 1). See the drive documentation in your upgrade kit for information on configuring devices for the cable select setting.

## Connecting Drive Cables

When you install a drive, you connect two cables—a DC power cable and a data cable—to the back of the drive and to the system board. Some drives may also have an audio connector; one end of the audio cable will attach to the drive connector and the other will attach to the system board.

### Drive Interface Connectors

Most interface connectors are keyed for correct insertion; that is, a notch or a missing pin on one connector matches a tab or a filled-in hole on the other connector.

When connecting an IDE cable, ensure you align the colored stripe with the pin 1 connector. When disconnecting an IDE cable, grasp the colored pull tab and pull until the connector detaches.

### Power Cable Connector

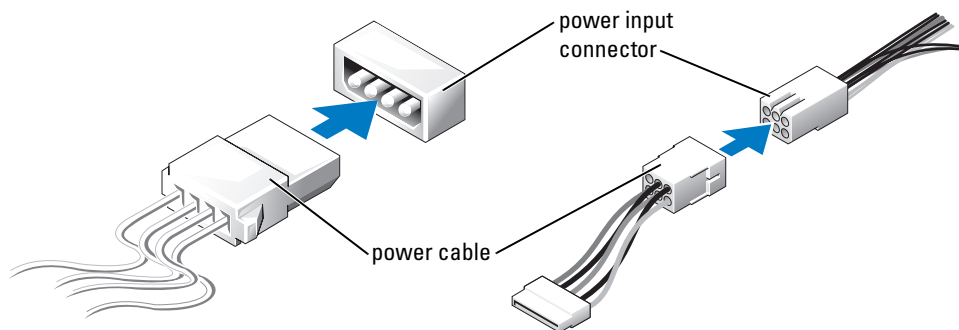

## Hard Drive

**⚠ CAUTION:** Before you begin any of the procedures in this section, follow the safety instructions located in the *Product Information Guide*.

**⚠ CAUTION:** To guard against electrical shock, always unplug your computer from the electrical outlet before opening the cover.

**➡ NOTICE:** To avoid damage to the drive, do not set it on a hard surface. Instead, set the drive on a surface, such as a foam pad, that will sufficiently cushion it.

- 1 If you are replacing a hard drive that contains data you want to keep, back up your files before you begin this procedure.
- 2 Follow the procedures in "Before You Begin" on page 47.
- 3 Remove the computer cover (see page 52).

### Removing a Hard Drive

- 1 Disconnect the power and data cables from the drive and from the system board.

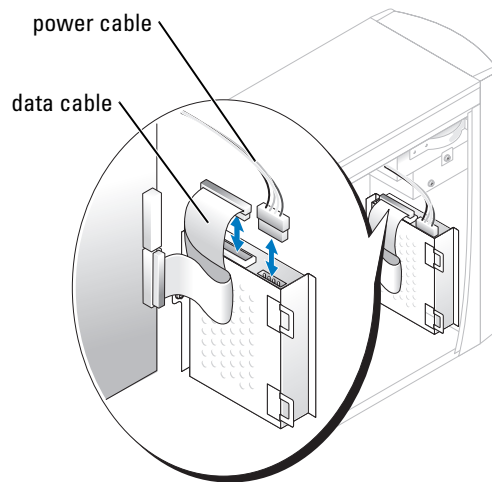

- 2 Remove the hard drive bracket from the computer:
  - a Remove the two screws securing the bracket to the computer.
  - b Rotate the bracket so that the bracket tabs can be disengaged from the computer.
  - c Remove the bracket containing the hard drive from the computer.

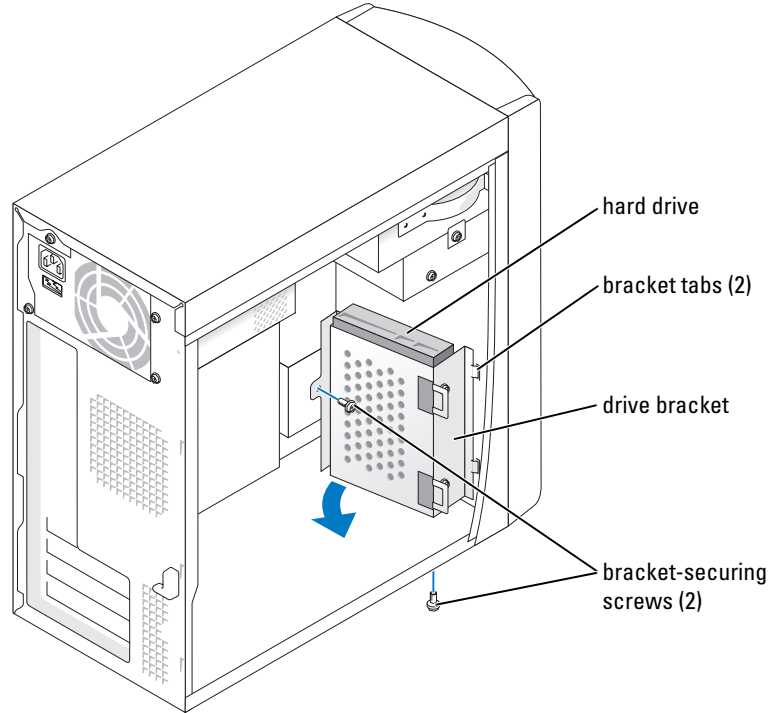

**3** If you are replacing the hard drive, remove the drive from the bracket:

- a** Remove the hard drive-securing screws.
- b** Remove the hard drive from the bracket.

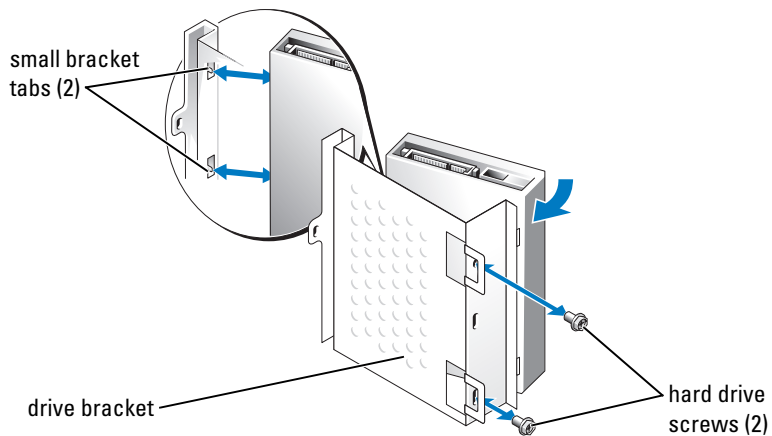

## Installing a Hard Drive

- 1 Unpack the replacement hard drive, and prepare it for installation.
- 2 Check the documentation for the drive to verify that it is configured for your computer.
- 3 Remove the hard drive bracket (see page 66).
- 4 Attach the hard drive to the hard drive bracket:
  - a Place the small bracket tabs into the drive screw holes on one side of the drive.
  - b Gently swing the drive toward the bracket and align the two screw holes on the other side of the drive with the screw holes on the bracket.
  - c Insert and tighten the two screws that secures the hard drive to the hard drive bracket.
- 5 Install the hard drive bracket containing the hard drive:
  - a Insert the two bracket tabs into the two bracket securing slots inside the computer.
  - b Rotate the bracket toward the front panel and align the bracket screw hole with the screw hole in the chassis.
  - c Replace the two screws that secure the bracket to the computer.

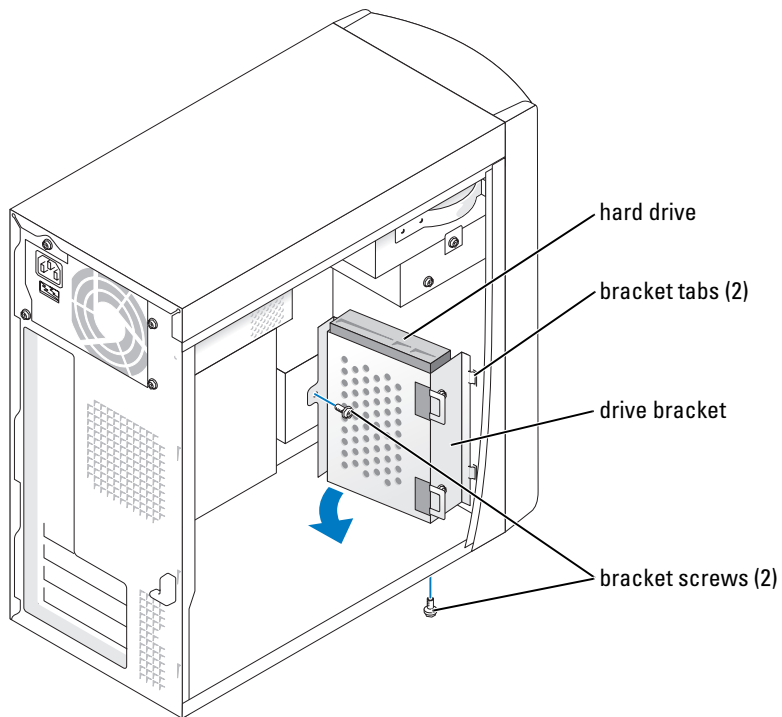

- 6 Connect a power cable to the drive.
- 7 Connect the data cable to the drive and to the system board (see page 54).
- 8 Close the computer cover (see page 78).
-  **NOTICE:** To connect a network cable, first plug the cable into the network wall jack and then plug it into the computer.
- 9 Connect your computer and devices to electrical outlets, and turn them on.  
See the documentation that came with the drive for instructions on installing any software required for drive operation.
- 10 If the drive you just installed is the primary drive, insert a bootable floppy disk into drive A.
- 11 Turn on the computer.
- 12 Enter system setup (see page 82), and update the appropriate **Drive** option.
- 13 Exit system setup, and restart the computer.
- 14 Partition and logically format your drive before you proceed to the next step.  
See the documentation for your operating system for instructions.
- 15 Test the hard drive by running the Dell Diagnostics (see page 38).
- 16 If the drive you just installed is the primary drive, install your operating system on the hard drive.

# Floppy Drive



**CAUTION:** Before you begin any of the procedures in this section, follow the safety instructions located in the *Product Information Guide*.



**CAUTION:** To guard against electrical shock, always unplug your computer from the electrical outlet before opening the cover.

- 1 Follow the procedures in "Before You Begin" on page 47.
- 2 Release and remove the front panel (see page 62).



**NOTE:** If you are adding a floppy drive, see "Installing a Floppy Drive" on page 71.

## Removing a Floppy Drive

- 1 Disconnect the power and data cables from the back of the floppy drive and from the system board (see page 54).

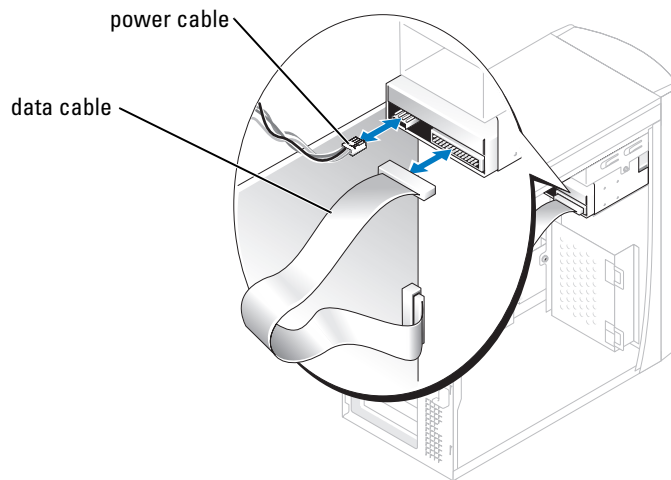

- 2 Remove the floppy drive bracket from the computer:
  - a Remove the bracket-securing screw for the floppy drive.
  - b Remove the bracket for the floppy drive from the computer.

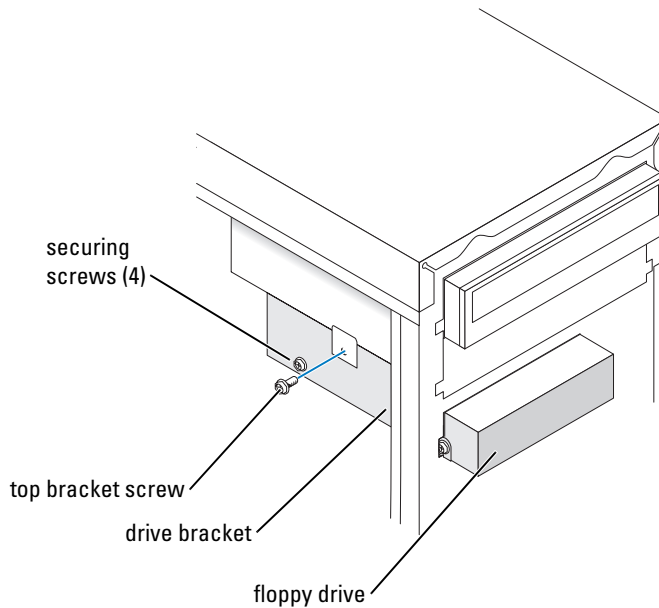

- 3 Remove the floppy drive from the bracket:
  - a Remove all four drive-securing screws (two on each side).
  - b Remove the floppy drive from the bracket.

### Installing a Floppy Drive

- 1 Remove the floppy drive bracket from the computer (see page 71).
- 2 If you are replacing a floppy drive, remove the drive from the bracket (see page 71).
- 3 Attach the floppy drive bracket to the floppy drive:
  - a Align the screw holes on the drive with the screw holes on the bracket.
  - b Insert and tighten all four drive-securing screws (two on each side).
- 4 Position the top of the floppy drive bracket so that it is completely flush with the bottom of the upper drive bay, and then slide the floppy drive bracket forward into position.



**NOTE:** The top of the floppy drive bracket has two slots that fit into two clips on the bottom of the upper drive bay. When the floppy drive bracket is properly mounted, it remains in place without support.

- 5 Secure the floppy drive bracket with the top bracket screw that came with your drive.
- 6 Reattach the front panel (see page 64).
- 7 Connect the data cable to the back of the drive and to the floppy drive connector on the system board (see page 54).

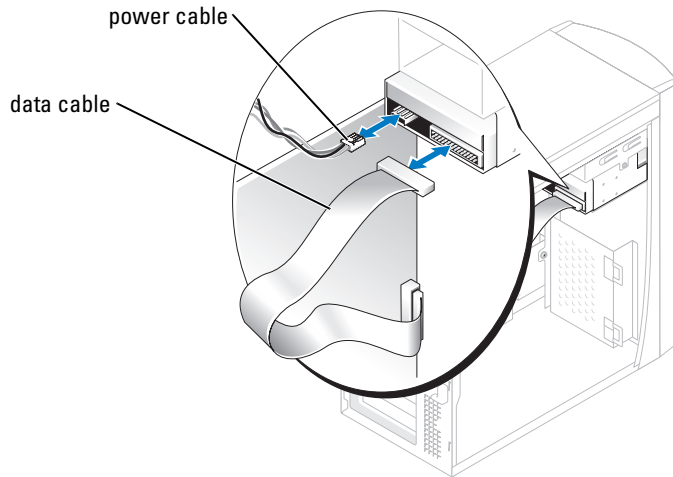

- ➔ **NOTICE:** Match the colored strip on the cable with pin 1 on the drive (pin 1 is marked as "1").
- 8 Reattach the front panel (see page 64).
- 9 Replace the computer cover (see page 78).
- ➔ **NOTICE:** To connect a network cable, first plug the cable in to the network wall jack and then plug it in to the computer.
- 10 Connect your computer and devices to their electrical outlets, and turn them on.  
See the documentation that came with the drive for instructions on installing any software required for drive operation.
- 11 Enter system setup (see page 82) and update the appropriate **Diskette Drive** option.
- 12 Verify that your computer works correctly by running the Dell Diagnostics (see page 38).



## CD/DVD Drive

**⚠ CAUTION:** Before you begin any of the procedures in this section, follow the safety instructions located in the *Product Information Guide*.

**⚠ CAUTION:** To guard against electrical shock, always unplug your computer from the electrical outlet before opening the cover.

- 1 Follow the procedures in "Before You Begin" on page 47.
- 2 Remove the computer cover (see page 52).
- 3 Release and remove the front panel (see page 62).

### Removing a CD/DVD Drive

- 1 Disconnect the power, audio, and CD/DVD drive cables from the back of the drive and from the system board.

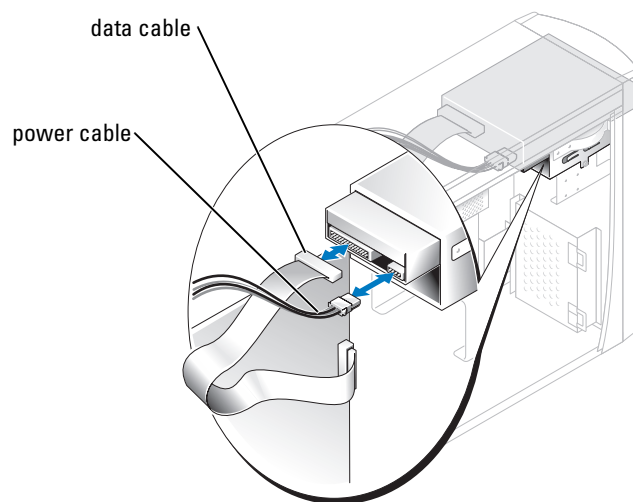

- 2 Remove the CD/DVD drive securing screw.
- 3 Slide the drive forward and remove it from the drive bay.

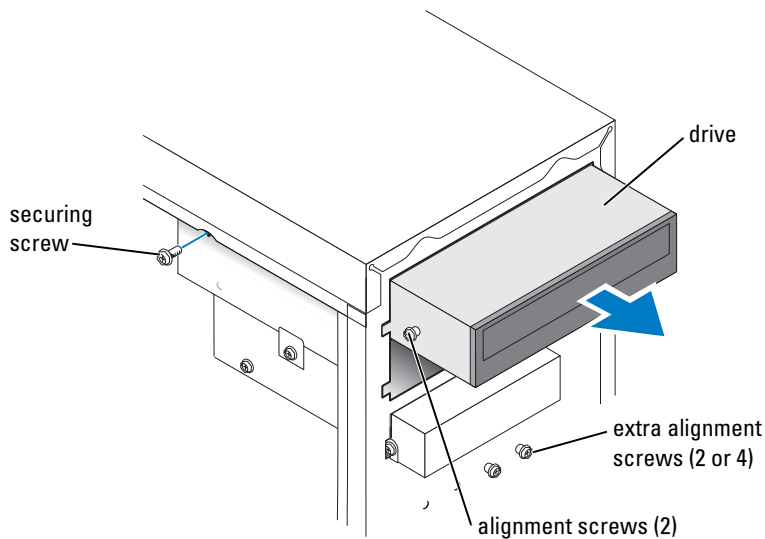

## Installing a CD/DVD Drive

- 1 If you are installing a new drive, unpack the drive and prepare it for installation.

Check the documentation that accompanied the drive to verify that the drive is configured for your computer. If you are installing an IDE drive, configure the drive for the cable select setting.

- 2 If you are replacing a drive, remove the existing drive (see page 73).

- 3 Gently slide the drive into place in the drive bay.

- 4 After the drive is in place, apply pressure to ensure that the drive is fully seated.

- 5 Use the securing screw that came with the drive to attach the drive to the computer.

- ➔ **NOTICE:** Match the colored strip on the cable with pin 1 on the drive (pin 1 is marked as "1").

- 6 Connect the power cable to the system board (see page 54).

- 7 Connect the power and CD/DVD drive cables to the drive and to the system board (see page 54).

- 8 If you are installing a drive that has its own controller card, install the controller card in a card slot.

- 9 Reattach the front panel (see page 64).

- 10 Replace the computer cover (see page 78).

- ➔ **NOTICE:** To connect a network cable, first plug the cable in to the network wall jack and then plug it into the computer.

- 11 Connect your computer and devices to their electrical outlets, and turn them on.  
See the documentation that came with the drive for instructions on installing any software required for drive operation.
- 12 Enter system setup (see page 82) and select the appropriate **Drive** option.
- 13 Verify that your computer works correctly by running Dell Diagnostics (see page 38).

### Adding a Second CD or DVD Drive

- 1 Ensure that the jumper setting on the new drive is set for "cable select" (see the documentation that came with the drive for information).
- 2 Remove two extra alignment screws, shown in the illustration on page 75, from the front of the computer and insert them into the drive.

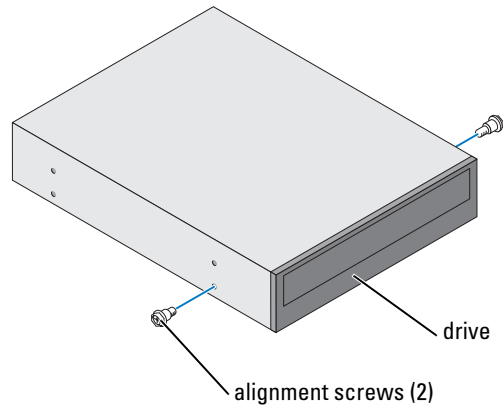

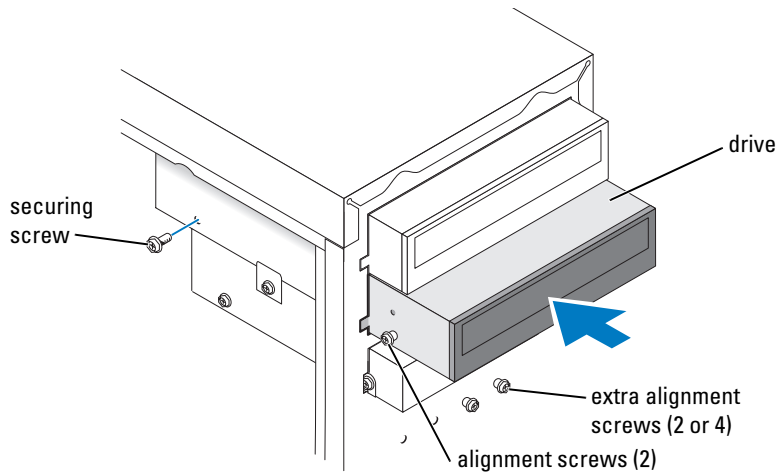

 **NOTE:** Some computers come with only two extra alignment screws; others come with four. You only need two alignment screws for this procedure.

- 3 Gently slide the drive into place in the drive bay.

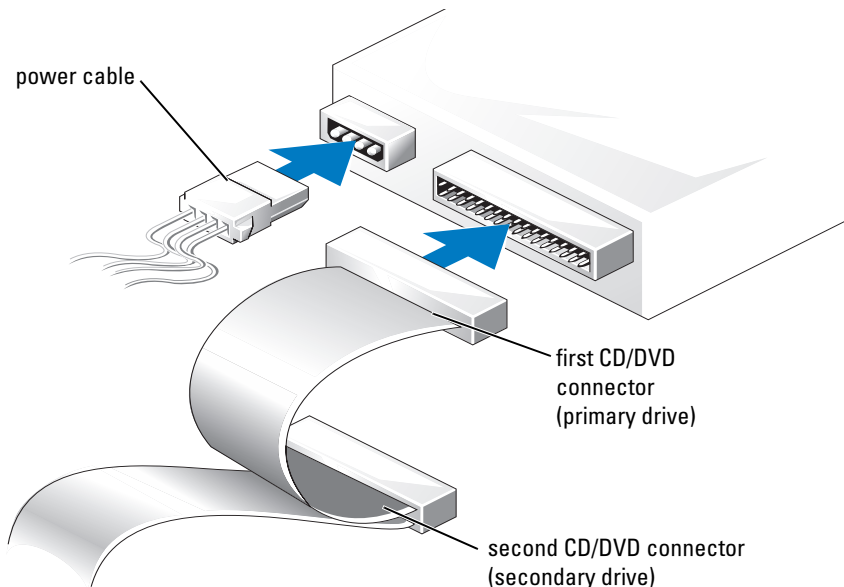

- 4 After the drive is in place, apply pressure to ensure that the drive is fully seated.
- 5 Use the securing screw that came with the drive to attach the drive to the computer.
- ➔ **NOTICE:** Match the colored strip on the cable with pin 1 on the drive (pin 1 is marked as "1").
- 6 Connect the power cable to the system board (see page 54).
- 7 Locate the data cable from the CD or DVD drive in the upper drive bay and connect its middle data connector to the new drive.



- 8 Reattach the front panel (see page 64).
- 9 Replace the computer cover (see page 78).
-  **NOTICE:** To connect a network cable, first plug the cable into the network wall jack and then plug it into the computer.
- 10 Connect your computer and devices to electrical outlets, and then turn them on.
- 11 See the documentation that came with the drive for instructions on installing any software required for drive operation.

## Battery



**CAUTION:** Before you begin any of the procedures in this section, follow the safety instructions located in the *Product Information Guide*.



**NOTICE:** To prevent static damage to components inside your computer, discharge static electricity from your body before you touch any of your computer's electronic components. You can do so by touching an unpainted metal surface on the computer chassis.

A coin-cell battery maintains computer configuration, date, and time information. The battery can last several years.

If you have to repeatedly reset time and date information after turning on the computer, replace the battery.



**CAUTION:** A new battery can explode if it is incorrectly installed. Replace the battery only with the same or equivalent type recommended by the manufacturer. Discard used batteries according to the manufacturer's instructions.

To replace the battery:

- 1 Record all the screens in system setup (see page 83) so that you can restore the correct settings in step 8.
- 2 Follow the procedures in "Before You Begin" on page 47.
- 3 Locate the battery socket (see "System Board Components" on page 54).
-  **NOTICE:** If you pry the battery out of its socket with a blunt object, be careful not to touch the system board with the object. Ensure that the object is inserted between the battery and the socket before you attempt to pry out the battery. Otherwise, you may damage the system board by prying off the socket or by breaking circuit traces on the system board.
- 4 Remove the battery by carefully prying it out of its socket with your fingers or with a blunt, nonconducting object such as a plastic screwdriver.
- 5 Insert the new battery into the socket with the side labeled "+" facing up, and snap the battery into place.

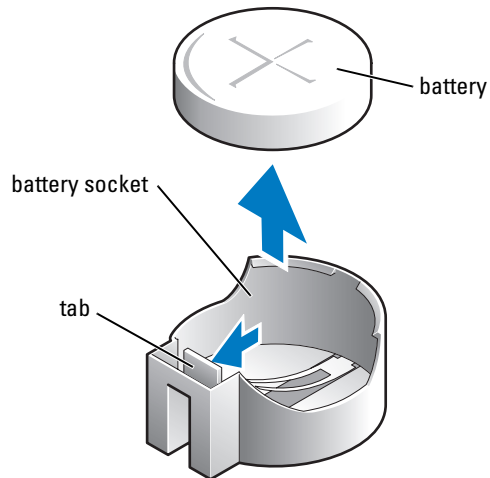

6 Replace the computer cover (see page 78).

➔ **NOTICE:** To connect a network cable, first plug the cable into the network device and then plug it into the computer.

7 Connect your computer and devices to electrical outlets, and turn them on.

8 Enter system setup (see page 83) and restore the settings you recorded in step 1.

9 Properly dispose of the old battery (see the "Battery Disposal" section of your *Product Information Guide*).

## Replacing the Computer Cover

⚠ **CAUTION:** Before you begin any of the procedures in this section, follow the safety instructions located in the *Product Information Guide*.

1 Ensure that all cables are connected, and fold cables out of the way.

Gently pull the power cables toward you so that they do not get caught underneath the drives.

2 Ensure that no tools or extra parts are left inside the computer.

3 Place the cover on the computer.

4 Slide the cover towards the front of the computer until it fits completely into place.

➔ **NOTICE:** To connect a network cable, first plug the cable into the network wall jack and then plug it into the computer.

5 Connect your computer and devices to electrical outlets, and turn them on.

# Appendix

## Specifications

---

### Processor

---

Processor type	Intel® Pentium® 4 with HT Technology and Intel Celeron® <b>NOTE:</b> Not all Pentium 4 processors support Hyper-Threading technology.
Level 1 (L1) cache	8 KB
Level 2 (L2) cache	128-KB or 512-KB (depending on your computer configuration) pipelined-burst, eight-way set associative, write-back SRAM

---

### Memory

---

Type	333- and 400-MHz DDR SDRAM <b>NOTE:</b> DDR333 and DDR400 memory runs at 266MHz when configured with Celeron 400MHz FSB processors <b>NOTE:</b> DDR333 memory runs at 320MHz when configured with Pentium 4 800MHz FSB processors
Memory connectors	two
Memory capacities	128-, 256-, 512-, or 1-GB non-ECC
Minimum memory	128 MB <b>NOTE:</b> Between 1 and 64 MB of system memory may be allocated to support graphics, depending on system memory size and other factors.
Maximum memory	2 GB
BIOS address	F0000h

---

### Computer Information

---

Chip set	Intel 865 GV
DMA channels	Seven
Interrupt levels	24
BIOS chip (NVRAM)	4 Mb

---

**Computer Information (continued)**

---

NIC	integrated network interface capable of 10/100 communication.
System Clock	Intel Pentium 4: 800 MHz Intel Celeron: 533 MHz

---

**Video**

---

Type	Integrated Intel Extreme Graphics 2
------	-------------------------------------

---

**Audio**

---

Type	AC97, Sound Blaster Emulation, ADI 1980 audio controller with 2.1 implementation
------	--

---

**Expansion Bus**

---

Bus type	PCI
Bus speed	33 MHz

**PCI**

connectors	three
connector size	120 pins
connector data width (maximum)	32 bits

---

**Drives**

---

Externally accessible:

One bay for a floppy drive, and two bays for CD/DVD drives

Available devices

Floppy drive, USB memory devices, CD drive, CD-RW drive, DVD drive, DVD-RW drive, and DVD and CD-RW combo drive

Internally accessible:

One bay for one 1-inch-high IDE hard drive

---

**Connectors**

---

External connectors:

Serial	9-pin connector; 16550C-compatible
Parallel	25-hole connector (bidirectional)
Video	15-hole connector
Network adapter	RJ45 connector



---

**Connectors (continued)**

---

PS/2 (keyboard and mouse)	6-pin mini-DIN
USB	two front-panel and four back-panel USB 2.0-compliant connectors
Audio	Three connectors for line-in, line-out, and microphone; one front-panel connector for headphones

## System board connectors:

Primary IDE drive	40-pin connector on PCI local bus
Secondary IDE drive	40-pin connector on PCI local bus
Floppy drive	34-pin connector
CD Audio	4-pin connector
Fan	3-pin connector

---

**Controls and Lights**

---

Power control	Push button
Hard-drive access light	Green
Link integrity light (on integrated network adapter)	No light for 10-Mb operation; green light for 100-Mb operation
Activity light (on integrated network adapter)	Yellow blinking light
Diagnostic lights	Four lights on the back panel

---

**Power**

---

## DC power supply:

Wattage	250 W
Heat dissipation	853 BTU/hr

**NOTE:** Heat dissipation is calculated based upon the power supply wattage rating.

Voltage (see the safety instructions located in the <i>Product Information Guide</i> for important voltage setting information)	manual selection power supplies — 90 to 135 V at 50/60 Hz; 180 to 265 V at 50/60 Hz
---	---

Backup battery	3-V CR2032 lithium coin cell
----------------	------------------------------

---

**Physical**

---

Height x width x depth	36.8 x 18.4 x 42.6 cm (14.5 x 7.25 x 16.75 inches)
Weight	10.4 kg (23 lb)

---

**Environmental**

---

Temperature:	
Operating	10° to 30°C (50° to 86°F) <b>NOTE:</b> At 30°C (86°F), the maximum operating altitude is 914 m (3000 ft).
Storage	-40° to 65°C (-40° to 149°F)
Relative humidity	20% to 80% (noncondensing)
Maximum vibration:	
Operating	0.25 G at 3 to 200 Hz at 0.5 octave/min
Storage	2.20 Grms at 10 to 500 Hz at 1 octave/min
Maximum shock:	
Operating	105 G, 2 ms
Storage	32 G with a velocity change of 596.9 cm/sec (235 inches/sec)
Altitude:	
Operating	-15.2 to 3048 m (-50 to 10,000 ft) <b>NOTE:</b> At 30°C (95°F), the maximum operating altitude is 914 m (3000 ft).
Storage	-15.2 to 10,670 m (-50 to 35,000 ft)

## System Setup

### Overview

Use system setup as follows:

- To change the system configuration information after you add, change, or remove any hardware in your computer
- To set or change a user-selectable option such as the user password
- To read the current amount of memory or set the type of hard drive installed

Before you use system setup, it is recommended that you write down the system setup screen information for future reference.

 **NOTICE:** Unless you are an expert computer user, do not change the settings for this program. Certain changes can make your computer work incorrectly.

## Entering System Setup

- 1 Turn on (or restart) your computer.
- 2 When the blue DELL™ logo appears, press <F2> immediately.

If you wait too long and the operating system logo appears, continue to wait until you see the Microsoft® Windows® desktop. Then shut down your computer (see page 47) and try again.

## System Setup Screens

The system setup screen displays current or changeable configuration information for your computer. Information on the screen is divided into three areas: the options list, active options field, and key functions.

<p><b>Options List</b> — This field appears on the left side of the system setup window. The field is a scrollable list containing features that define the configuration of your computer, including installed hardware, power conservation, and security features.</p> <p>Scroll up and down the list by using the up- and down-arrow keys. As an option is highlighted, the <b>Option Field</b> displays more information about that option and the option's current and available settings.</p> <p>Press &lt;Enter&gt; to expand or contract each of the main option fields.</p>	<p><b>Option Field</b> — This field contains information about each option. In this field you can view your current settings and make changes to your settings.</p> <p>Use the right and left arrow keys to highlight an option. Press &lt;Enter&gt; to make that selection active.</p> <hr/> <p><b>Key Functions</b> — This field appears below the <b>Option Field</b> and lists keys and their functions within the active system setup field.</p>
--	---

## System Setup Options



**NOTE:** Depending on your computer and installed devices, the items listed in this section may not appear, or may not appear exactly as listed.

<b>System</b>	
System Time	Identifies the system clock time as formatted.
System Date	Identifies the date as formatted: Weekday Month
<b>Drive Configuration</b>	
Diskette Drive	Identifies and defines the floppy drive attached to the FLOPPY connector on the system board as <b>Off</b> , <b>USB</b> , <b>Internal</b> , or <b>Read Only</b> .
Primary Master Drive	Identifies the drive attached to the PRI IDE connectors on the system board, and lists the capacity for a hard drive.
Primary Slave Drive	Identifies and defines the slave drive to the primary master drive on PRI IDE. Can be turned <b>Off</b> or set to <b>Auto</b> (to detect the drive) and if present, lists the capacity for the drive.
Secondary Master Drive	Identifies the drive attached to the SEC IDE connectors on the system board, and lists the capacity for a hard drive (lists <b>n/a</b> for optical devices such as CD/DVD drives).
Secondary Slave Drive	Identifies and defines the slave drive to the secondary master drive on SEC IDE. Can be turned <b>Off</b> or set to <b>Auto</b> (to detect the drive) and if present, lists the capacity for the drives (lists <b>n/a</b> for optical devices such as CD/DVD drives).
IDE Drive UDMA	Identifies whether or not to enable UDMA (the Ultra Direct Memory Access mass storage interface).
<b>Hard-Disk Drive Sequence</b>	

Identifies the device types that are in first and second priority for booting the system.

- System BIOS - devices such as hard drives and CD/DVD ROMs as listed in the Boot Sequence section of this System Setup program
- USB device - a device such as an external hard drive or USB memory key

By default, **System BIOS boot devices** is first (in position 1), followed by **USB device**. To change the order, select an option and press the + or - key to move the selection up or down in priority.

**NOTE:** If you insert a boot device and restart the computer, this option appears in the system setup menu. To boot from a USB memory device, select the USB device and move it so it becomes the first device in the list.

---

## Boot Sequence

---

Lists the drives in the order by which they boot.

- Floppy device - Identifies and defines the floppy drive attached to the FLOPPY connector on the system board. If there is no installed drive, it appears as **Floppy device (not installed)**.
- Hard-Disk Drive - Identifies the hard drive. The drive is listed by its drive letter (such as **Hard Disk Drive C:**).
- IDE - Identifies and defines the optical drive attached to the IDE connector on the system board. If there is no installed drive, it appears as **IDE CD-ROM Device (not installed)**.

An included device displays with a checkmark next to its listing. To remove the device from the boot sequence, use the spacebar to clear the checkmark. To change the boot order, use + or - to move the listing up or down.

---

## Memory Information

---

Installed System Memory	Identifies and lists the amount of detected memory.
System Memory Speed	Identifies and lists the speed of the detected memory in megahertz (MHz). For information on supported memory see "Memory" on page 79.
System Channel Mode	Identifies and lists the installed memory as either <b>Dual</b> or <b>Single</b> channel. For information on supported memory see "Memory" on page 79.
AGP Aperture	Identifies and lists the amount of memory to dedicate for graphics. The values vary depending on the capacity of installed memory.

---

## CPU Information

---

Hyperthreading	If your computer's processor supports Hyper-Threading, This section displays the following options: <ul style="list-style-type: none"><li>• <b>Disabled</b> - Hyper-Threading is Off.</li><li>• <b>Enabled</b> - Hyper-Threading is On.</li></ul>
CPU Speed	Lists the options for setting the processor speed as <b>Normal</b> or <b>Compatible</b> . <b>NOTICE:</b> Changing the CPU Speed is not recommended, this may shorten the life of the processor and void the warranty.
Bus Speed	Lists the speed that the processor runs in megahertz (MHz)
Processor ID	Lists the processor <b>Clock Speed</b> , and <b>L2 Cache Size</b> .

<b>Integrated Devices</b>	
Sound	Enables or disables the onboard audio controller
Network Interface Controller	You can set the NIC to <b>On</b> (default), <b>Off</b> , or <b>On w/ PXE</b> . When the <b>On w/ PXE</b> setting is active (available only for the future boot process), the computer prompts the user to press <Ctrl><Alt><b>. Pressing this key combination causes a menu to display that allows you to select a method for booting from a network server. If a boot routine is not available from the network server, the computer attempts to boot from the next device in the boot sequence list.
Mouse Port	Enables or disables the onboard PS/2-compatible mouse controller.
USB Emulation	Set to <b>On</b> (default) so that USB devices will be detected and supported in the operating system.  The <b>No Boot</b> option restricts external access to drive data. Use this option to prohibit users from booting the computer using an external USB device.
USB Controller	Set to <b>On</b> (default) so that multiple USB devices can be connected to a system without compromising data speed. When set to <b>Off</b> , all connected ports share a set data speed that is equivalent to one port.
Serial Port #1	Identifies and defines the serial port settings. <b>Auto</b> , the default setting, automatically configures a connector to a particular designation ( <b>COM1</b> or <b>COM3</b> ).
Parallel Port Mode	Identifies and defines the parallel port settings. You can set the parallel port to <b>Off</b> , <b>AT</b> , <b>PS/2</b> , <b>EPP</b> , or <b>ECP</b> .
Parallel Port I/O Address	Identifies the address for the parallel port.
Diskette Interface	Identifies and defines the floppy drive interface. You can set the interface to <b>Auto</b> , <b>Read Only</b> , or <b>Off</b> .
Primary Video Controller	This setting specifies which video controller is primary when two video controllers are present on the computer.
Onboard Video Buffer	Sets the amount of system memory to be reserved for the onboard video controller.
<b>Power Management</b>	
Suspend Mode	The options are <b>S1</b> , a suspend state where the computer is running in a low-power mode, and <b>S3</b> , a standby state where the power is reduced or turned off for most components, however, system memory remains active.
AC Power Recovery	Determines what happens when AC power is restored to the computer.
Low Power Mode	When <b>Low Power Mode</b> is selected, remote wakeup events no longer power up from <b>Hibernate</b> or <b>Off</b> .

<b>System Security</b>	This section displays available system security options.
Password Status	This option locks the system password field with the setup password. When the field is locked, the option to disable password security by pressing <Ctrl><Enter> when the computer starts is no longer available.
System Password	Displays the current status of the system's password security feature as <b>Enabled</b> or <b>Disabled</b> .
Setup Password	Displays the current status of the system's password security feature and allows a new system password to be assigned and verified.
PXE BIS Default Policy	Used to set the NIC On w/PCE feature policy to <b>Deny</b> , <b>Accept</b> , or <b>Reset</b> . See "Network Interface Controller" on page 86.
Keyboard Numlock	Sets the numeric keyboard option to <b>On</b> , or <b>Off</b> . This setting overrides the option set via the keyboard.
Report Keyboard Errors	Used to set the keyboard error reporting <b>On</b> , or <b>Off</b> .
Auto Power On	Identifies if auto power on is <b>Disabled</b> or <b>Enabled</b> .
Fast Boot	When set to <b>On</b> (default), your computer starts more quickly because it skips certain configurations and tests.
OS Install Mode	This setting turns the <b>OS Install Mode</b> either <b>On</b> or <b>Off</b> (default).
IDE Hard Drive Acoustics Mode	<p><b>Quiet</b> (default setting) — The hard drive operates at its most quiet setting.</p> <p><b>Performance</b> — The hard drive operates at its maximum speed.</p> <p><b>Bypass</b> — Your computer does not test or change the current acoustics mode setting.</p> <p><b>Suggested</b> — The hard drive operates at the level suggested by the drive manufacturer.</p> <p><b>NOTE:</b> Switching to performance mode may cause the drive to be noisier, but its performance is not affected.</p> <p>Changing the acoustics setting does not alter your hard-drive image.</p>
System Event Log	Displays the system event log.
Asset Tag	Displays the computer's unique Asset Tag.

<b>POST Behavior</b>	
Fastboot	When set to <b>On</b> (default), your computer starts more quickly because it skips certain configurations and tests.
Numlock Key	This option involves the rightmost bank of keys on your keyboard. When set to <b>On</b> (default), this option activates the numeric and mathematical features shown at the top of each key. When set to <b>Off</b> , this option activates the cursor-control functions labeled on the bottom of each key.
OS Install	This setting turns the <b>OS Install Mode</b> either <b>On</b> or <b>Off</b> (default).
POST Hotkeys	This option allows you to specify the function keys to display on the screen when the computer starts. <b>F2</b> is used to access the System Setup program and <b>F12</b> is used to access the Boot Menu.
Keyboard Errors	This option disables or enables keyboard error reporting when the computer starts.

## Boot Sequence

This feature allows you to change the boot sequence for devices.

### Option Settings

- **Diskette Drive** — The computer attempts to boot from the floppy drive. If the floppy disk in the drive is not bootable, if no floppy disk is in the drive, or if there is no floppy drive installed in the computer, the computer generates an error message.
- **Hard Drive** — The computer attempts to boot from the primary hard drive. If no operating system is on the drive, the computer generates an error message.
- **CD Drive** — The computer attempts to boot from the CD drive. If no CD is in the drive, or if the CD has no operating system, the computer generates an error message.
- **USB Flash Device** — Insert the memory device into a USB port and restart the computer. When **F12 = Boot Menu** appears in the upper-right corner of the screen, press <F12>. The BIOS detects the device and adds the USB flash option to the boot menu.



**NOTE:** To boot to a USB device, the device must be bootable. To make sure your device is bootable, check the device documentation.

### Changing Boot Sequence for the Current Boot

You can use this feature, for example, to restart your computer to a USB device such as a floppy drive, memory key, or CD-RW drive.



**NOTE:** If you are booting to a USB floppy drive, you must first set the floppy drive to **OFF** in system setup (see page 82).

- 1 If you are booting to a USB device, connect the USB device to a USB connector (see page 54).
- 2 Turn on (or restart) your computer.



- 3 When **F2 = Setup**, **F12 = Boot Menu** appears in the upper-right corner of the screen, press <F12>.

If you wait too long and the operating system logo appears, continue to wait until you see the Microsoft Windows desktop. Then shut down your computer (see page 47) and try again.

The **Boot Device Menu** appears, listing all available boot devices. Each device has a number next to it.

- 4 At the bottom of the menu, enter the number of the device that is to be used for the current boot only. For example, if you are booting to a USB memory key, highlight **USB Flash Device** and press <Enter>.



**NOTE:** To boot to a USB device, the device must be bootable. To make sure that your device is bootable, check the device documentation.

### Changing Boot Sequence for Future Boots

- 1 Enter system setup (see page 82).
- 2 Use the arrow keys to highlight the **Boot Sequence** menu option and press <Enter> to access the menu.



**NOTE:** Write down your current boot sequence in case you want to restore it.

- 3 Press the up- and down-arrow keys to move through the list of devices.
- 4 Press the spacebar to enable or disable a device (enabled devices have a checkmark).
- 5 Press plus (+) or minus (-) to move a selected device up or down the list.

## Clearing Forgotten Passwords

**⚠ CAUTION:** Before you begin any of the procedures in this section, follow the safety instructions located in the *Product Information Guide*.

- 1 Follow the procedures in "Before You Begin" on page 47.

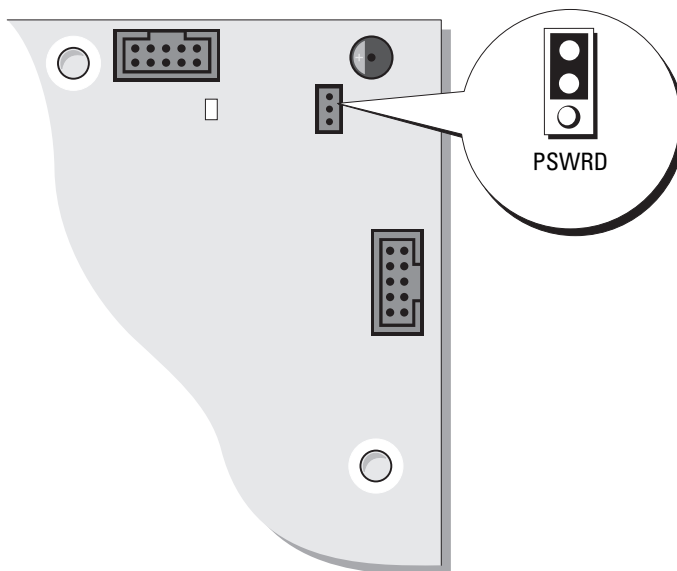

- 2 Locate the 3-pin password jumper (PSWRD) on the system board (see page 54), and attach the jumper plug to pins 2 and 3 to clear the password.

**✍ NOTE:** When you receive your computer, the jumper plug is attached to pins 1 and 2.

- 3 Close the computer cover (see page 78).
- 4 Connect your computer and monitor to electrical outlets, and turn them on.
- 5 After the Microsoft® Windows® desktop appears on your computer, shut down the computer. (see page 47).
- 6 Turn off the monitor and disconnect it from the electrical outlet.
- 7 Disconnect the computer power cable from the electrical outlet, and press the power button to ground the system board.
- 8 Open the computer cover (see page 52).
- 9 Locate the 3-pin password jumper on the system board (see page 54) and attach the jumper to pins 1 and 2 to re-enable the password feature.
- 10 Replace the computer cover (see page 78).

 **NOTICE:** To connect a network cable, first plug the cable into the network wall jack and then plug it into the computer.

11 Connect your computer and devices to electrical outlets, and turn them on.

## Cleaning Your Computer

 **CAUTION:** Before you begin any of the procedures in this section, follow the safety instructions located in the *Product Information Guide*.

### Computer, Keyboard, and Monitor

 **CAUTION:** Before you clean your computer, disconnect the computer from the electrical outlet. Clean your computer with a soft cloth dampened with water. Do not use liquid or aerosol cleaners, which may contain flammable substances.

- Use a vacuum cleaner with a brush attachment to gently remove dust from the slots and holes on your computer and from between the keys on the keyboard.

 **NOTICE:** Do not wipe the display screen with any soap or alcohol solution. Doing so may damage the antiglare coating.

- To clean your monitor screen, lightly dampen a soft, clean cloth with water. If possible, use a special screen-cleaning tissue or solution suitable for the monitor's antistatic coating.
- Wipe the keyboard, computer, and plastic part of the monitor with a soft cleaning cloth moistened with a solution of three parts water and one part dishwashing detergent.

Do not soak the cloth or let water drip inside your computer or keyboard.

### Mouse

If your screen cursor skips or moves abnormally, clean the mouse. To clean a non-optical mouse:

- 1 Turn the retainer ring on the underside of your mouse counterclockwise, and then remove the ball.
- 2 Wipe the ball with a clean, lint-free cloth.
- 3 Blow carefully into the ball cage to dislodge dust and lint.
- 4 If the rollers inside the ball cage are dirty, clean the rollers with a cotton swab moistened lightly with isopropyl alcohol.
- 5 Re-center the rollers in their channels if they are misaligned. Ensure that fluff from the swab is not left on the rollers.
- 6 Replace the ball and retainer ring, and turn the retainer ring clockwise until it clicks into place.

### Floppy Drive

 **NOTICE:** Do not attempt to clean drive heads with a swab. You might accidentally misalign the heads, which prevents the drive from operating.

Clean your floppy drive using a commercially available cleaning kit. These kits contain pretreated floppy disks to remove contaminants that accumulate during normal operation.

## CDs and DVDs

- ➔ **NOTICE:** Always use compressed air to clean the lens in the CD/DVD drive, and follow the instructions that come with the compressed air. Never touch the lens in the drive.

If you notice problems, such as skipping, with the playback quality of your CDs or DVDs, try cleaning the discs.

- 1 Hold the disc by its outer edge. You can also touch the inside edge of the center hole.

- ➔ **NOTICE:** To prevent damaging the surface, do not wipe in a circular motion around the disc.

- 2 With a soft, lint-free cloth, gently wipe the bottom of the disc (the unlabeled side) in a straight line from the center to the outer edge of the disc.

For stubborn dirt, try using water or a diluted solution of water and mild soap. You can also purchase commercial products that clean discs and provide some protection from dust, fingerprints, and scratches. Cleaning products for CDs are safe to use on DVDs.

## Dell Technical Support Policy (U.S. Only)

Technician-assisted technical support requires the cooperation and participation of the customer in the troubleshooting process and provides for restoration of the operating system, software programs, and hardware drivers to the original default configuration as shipped from Dell, as well as the verification of appropriate functionality of the computer and all Dell-installed hardware. In addition to this technician-assisted technical support, online technical support is available at [support.dell.com](http://support.dell.com). Additional technical support options may be available for purchase.

Dell provides limited technical support for the computer and any "Dell-installed" software and peripherals<sup>1</sup>. Support for third-party software and peripherals is provided by the original manufacturer, including those purchased and/or installed through Dell Software and Peripherals, Readyware, and Custom Factory Integration<sup>2</sup>.

<sup>1</sup> Repair services are provided pursuant to the terms and conditions of your limited warranty and any optional support service contract purchased with the computer.

<sup>2</sup> All Dell-standard components included in a Custom Factory Integration (CFI) project are covered by the standard Dell limited warranty for your computer. However, Dell also extends a parts replacement program to cover all nonstandard, third-party hardware components integrated through CFI for the duration of the computer's service contract.

## Definition of "Dell-Installed" Software and Peripherals

Dell-installed software includes the operating system and some of the software programs that are installed on the computer during the manufacturing process (Microsoft<sup>®</sup> Office, Norton Antivirus, and so on).

Dell-installed peripherals include any internal expansion cards, or Dell-branded module bay or PC Card accessories. In addition, any Dell-branded monitors, keyboards, mice, speakers, microphones for telephonic modems, docking stations/port replicators, networking products, and all associated cabling are included.

## Definition of "Third-Party" Software and Peripherals

Third-party software and peripherals include any peripheral, accessory, or software program sold by Dell not under the Dell brand (printers, scanners, cameras, games, and so on). Support for all third-party software and peripherals is provided by the original manufacturer of the product.

## FCC Notices (U.S. Only)

Most Dell computer systems are classified by the Federal Communications Commission (FCC) as Class B digital devices. To determine which classification applies to your computer system, examine all FCC registration labels located on the bottom, side, or back panel of your computer, on card-mounting brackets, and on the cards themselves. If any one of the labels carries a Class A rating, your entire system is considered to be a Class A digital device. If *all* labels carry an FCC Class B rating as distinguished by either an FCC ID number or the FCC logo, (FCC), your system is considered to be a Class B digital device.

Once you have determined your system's FCC classification, read the appropriate FCC notice. Note that FCC regulations provide that changes or modifications not expressly approved by Dell could void your authority to operate this equipment.

This device complies with Part 15 of the FCC Rules. Operation is subject to the following two conditions:

- This device may not cause harmful interference.
- This device must accept any interference received, including interference that may cause undesired operation.

### Class A

This equipment has been tested and found to comply with the limits for a Class A digital device pursuant to Part 15 of the FCC Rules. These limits are designed to provide reasonable protection against harmful interference when the equipment is operated in a commercial environment. This equipment generates, uses, and can radiate radio frequency energy and, if not installed and used in accordance with the manufacturer's instruction manual, may cause harmful interference with radio communications. Operation of this equipment in a residential area is likely to cause harmful interference, in which case you will be required to correct the interference at your own expense.

### Class B

This equipment has been tested and found to comply with the limits for a Class B digital device pursuant to Part 15 of the FCC Rules. These limits are designed to provide reasonable protection against harmful interference in a residential installation. This equipment generates, uses, and can radiate radio frequency energy and, if not installed and used in accordance with the manufacturer's instruction manual, may cause interference with radio communications. However, there is no guarantee that interference will not occur in a

particular installation. If this equipment does cause harmful interference to radio or television reception, which can be determined by turning the equipment off and on, you are encouraged to try to correct the interference by one or more of the following measures:

- Reorient or relocate the receiving antenna.
- Increase the separation between the equipment and the receiver.
- Connect the equipment into an outlet on a circuit different from that to which the receiver is connected.
- Consult the dealer or an experienced radio/television technician for help.

### **FCC Identification Information**

The following information is provided on the device or devices covered in this document in compliance with FCC regulations:

- Model number: DMC
- Company name:

Dell Inc.  
One Dell Way  
Round Rock, Texas 78682 USA  
512-338-4400

### **Contacting Dell**

To contact Dell electronically, you can access the following websites:

- [www.dell.com](http://www.dell.com)
- [support.dell.com](http://support.dell.com) (technical support)
- [premiersupport.dell.com](http://premiersupport.dell.com) (technical support for educational, government, healthcare, and medium/large business customers, including Premier, Platinum, and Gold customers)

For specific web addresses for your country, find the appropriate country section in the table below.

**NOTE:** Toll-free numbers are for use within the country for which they are listed.

When you need to contact Dell, use the electronic addresses, telephone numbers, and codes provided in the following table. If you need assistance in determining which codes to use, contact a local or an international operator.

<b>Country (City) International Access Code Country Code City Code</b>	<b>Department Name or Service Area, Website and E-Mail Address</b>	<b>Area Codes, Local Numbers, and Toll-Free Numbers</b>
Anguilla	General Support	toll-free: 800-335-0031
Antigua and Barbuda	General Support	1-800-805-5924
Argentina (Buenos Aires)	Website: <a href="http://www.dell.com.ar">www.dell.com.ar</a>	
International Access Code: 00	E-mail: <a href="mailto:us_latin_services@dell.com">us_latin_services@dell.com</a>	
Country Code: 54	E-mail for desktop and portable computers: <a href="mailto:la-techsupport@dell.com">la-techsupport@dell.com</a>	
City Code: 11	E-mail for servers and EMC: <a href="mailto:la_enterprise@dell.com">la_enterprise@dell.com</a>	
	Customer Care	toll-free: 0-800-444-0730
	Tech Support	toll-free: 0-800-444-0733
	Tech Support Services	toll-free: 0-800-444-0724
	Sales	0-810-444-3355
Aruba	General Support	toll-free: 800-1578
Australia (Sydney)	E-mail (Australia): <a href="mailto:au_tech_support@dell.com">au_tech_support@dell.com</a>	
International Access Code: 0011	E-mail (New Zealand): <a href="mailto:nz_tech_support@dell.com">nz_tech_support@dell.com</a>	
Country Code: 61	Home and Small Business	1-300-65-55-33
City Code: 2	Government and Business	toll-free: 1-800-633-559
	Preferred Accounts Division (PAD)	toll-free: 1-800-060-889
	For servers and storage	toll-free: 1-800-505-095
	For desktop and portable computers	toll-free: 1-800-733-314
	Customer Care	toll-free: 1-800-819-339
	Corporate Sales	toll-free: 1-800-808-385
	Transaction Sales	toll-free: 1-800-808-312
	Fax	toll-free: 1-800-818-341

<b>Country (City) International Access Code Country Code City Code</b>	<b>Department Name or Service Area, Website and E-Mail Address</b>	<b>Area Codes, Local Numbers, and Toll-Free Numbers</b>
<b>Austria (Vienna)</b>	Website: <a href="http://support.euro.dell.com">support.euro.dell.com</a>	
International Access Code: 900	E-mail: <a href="mailto:tech_support_central_europe@dell.com">tech_support_central_europe@dell.com</a>	
Country Code: 43	Home/Small Business Sales	0820 240 530 00
City Code: 1	Home/Small Business Fax	0820 240 530 49
	Home/Small Business Customer Care	0820 240 530 14
	Preferred Accounts/Corporate Customer Care	0820 240 530 16
	Home/Small Business Technical Support	0820 240 530 14
	Preferred Accounts/Corporate Technical Support	0660 8779
	Switchboard	0820 240 530 00
<b>Bahamas</b>	General Support	toll-free: 1-866-278-6818
<b>Barbados</b>	General Support	1-800-534-3066
<b>Belgium (Brussels)</b>	Website: <a href="http://support.euro.dell.com">support.euro.dell.com</a>	
International Access Code: 00	E-mail for French Speaking Customers: <a href="http://support.euro.dell.com/be/fr/emaildell/">support.euro.dell.com/be/fr/emaildell/</a>	
Country Code: 32	Technical Support	02 481 92 88
City Code: 2	Technical Support Fax	02 481 92 95
	Customer Care	02 713 15 65
	Corporate Sales	02 481 91 00
	Fax	02 481 92 99
	Switchboard	02 481 91 00
<b>Bermuda</b>	General Support	1-800-342-0671
<b>Bolivia</b>	General Support	toll-free: 800-10-0238
<b>Brazil</b>	Website: <a href="http://www.dell.com/br">www.dell.com/br</a>	
International Access Code: 00	Customer Support, Technical Support	0800 90 3355
Country Code: 55	Technical Support Fax	51 481 5470
City Code: 51	Customer Care Fax	51 481 5480
	Sales	0800 90 3390
<b>British Virgin Islands</b>	General Support	toll-free: 1-866-278-6820
<b>Brunei</b>	Customer Technical Support (Penang, Malaysia)	604 633 4966
Country Code: 673	Customer Service (Penang, Malaysia)	604 633 4949
	Transaction Sales (Penang, Malaysia)	604 633 4955



<b>Country (City) International Access Code Country Code City Code</b>	<b>Department Name or Service Area, Website and E-Mail Address</b>	<b>Area Codes, Local Numbers, and Toll-Free Numbers</b>
Canada (North York, Ontario) International Access Code: 011	Online Order Status: <a href="http://www.dell.ca/ostatus">www.dell.ca/ostatus</a> AutoTech (automated technical support) Customer Care (Home Sales/Small Business) Customer Care (med./large business, government) Technical Support (Home Sales/Small Business) Technical Support (med./large bus., government) Sales (Home Sales/Small Business) Sales (med./large bus., government) Spare Parts Sales & Extended Service Sales	toll-free: 1-800-247-9362 toll-free: 1-800-847-4096 toll-free: 1-800-326-9463 toll-free: 1-800-847-4096 toll-free: 1-800-387-5757 toll-free: 1-800-387-5752 toll-free: 1-800-387-5755 1 866 440 3355
Cayman Islands	General Support	1-800-805-7541
Chile (Santiago) Country Code: 56 City Code: 2	Sales, Customer Support, and Technical Support	toll-free: 1230-020-4823

<b>Country (City) International Access Code Country Code City Code</b>	<b>Department Name or Service Area, Website and E-Mail Address</b>	<b>Area Codes, Local Numbers, and Toll-Free Numbers</b>
China (Xiamen) Country Code: 86 City Code: 592	Technical Support website: <a href="http://support.dell.com.cn">support.dell.com.cn</a> Technical Support E-mail: <a href="mailto:cn_support@dell.com">cn_support@dell.com</a> Technical Support Fax Technical Support (Dimension™ and Inspiron™) Technical Support (OptiPlex™, Latitude™, and Dell Precision™) Technical Support (servers and storage) Technical Support (projectors, PDAs, printers, switches, routers, and so on) Customer Advocacy Customer Advocacy Fax Home and Small Business Preferred Accounts Division Large Corporate Accounts GCP Large Corporate Accounts Key Accounts Large Corporate Accounts North Large Corporate Accounts North Government and Education Large Corporate Accounts East Large Corporate Accounts East Government and Education Large Corporate Accounts Queue Team Large Corporate Accounts South Large Corporate Accounts West Large Corporate Accounts Spare Parts	818 1350 toll-free: 800 858 2969 toll-free: 800 858 0950 toll-free: 800 858 0960 toll-free: 800 858 2920 toll-free: 800 858 2060 592 818 1308 toll-free: 800 858 2222 toll-free: 800 858 2557 toll-free: 800 858 2055 toll-free: 800 858 2628 toll-free: 800 858 2999 toll-free: 800 858 2955 toll-free: 800 858 2020 toll-free: 800 858 2669 toll-free: 800 858 2572 toll-free: 800 858 2355 toll-free: 800 858 2811 toll-free: 800 858 2621
Colombia	General Support	980-9-15-3978
Costa Rica	General Support	0800-012-0435

<b>Country (City) International Access Code Country Code City Code</b>	<b>Department Name or Service Area, Website and E-Mail Address</b>	<b>Area Codes, Local Numbers, and Toll-Free Numbers</b>
Czech Republic (Prague)	Website: support.euro.dell.com	
International Access Code: 00	E-mail: czech_dell@dell.com	
Country Code: 420	Technical Support	02 2186 27 27
City Code: 2	Technical Support Fax	02 2186 27 28
	Customer Care	02 2186 27 11
	Customer Care Fax	02 2186 27 14
	Switchboard	02 2186 27 11
Denmark (Copenhagen)	Website: support.euro.dell.com	
International Access Code: 00	E-mail Support (portable computers): den_nbk_support@dell.com	
Country Code: 45	E-mail Support (desktop computers): den_support@dell.com	
	E-mail Support (servers): Nordic_server_support@dell.com	
	Technical Support	7023 0182
	Customer Care (Relational)	7023 0184
	Home/Small Business Customer Care	3287 5505
	Switchboard (Relational)	3287 1200
	Switchboard Fax (Relational)	3287 1201
	Switchboard (Home/Small Business)	3287 5000
	Switchboard Fax (Home/Small Business)	3287 5001
Dominica	General Support	toll-free: 1-866-278-6821
Dominican Republic	General Support	1-800-148-0530
Ecuador	General Support	toll-free: 999-119
El Salvador	General Support	01-899-753-0777

<b>Country (City) International Access Code Country Code City Code</b>	<b>Department Name or Service Area, Website and E-Mail Address</b>	<b>Area Codes, Local Numbers, and Toll-Free Numbers</b>
Finland (Helsinki) International Access Code: 990 Country Code: 358 City Code: 9	Website: support.euro.dell.com E-mail: fin_support@dell.com E-mail Support (servers): Nordic_support@dell.com	
	Technical Support	09 253 313 60
	Technical Support Fax	09 253 313 81
	Relational Customer Care	09 253 313 38
	Home/Small Business Customer Care	09 693 791 94
	Fax	09 253 313 99
	Switchboard	09 253 313 00
France (Paris) (Montpellier) International Access Code: 00 Country Code: 33 City Codes: (1) (4)	Website: support.euro.dell.com E-mail: support.euro.dell.com/fr/fr/emaildell/ <b>Home and Small Business</b>	
	Technical Support	0825 387 270
	Customer Care	0825 823 833
	Switchboard	0825 004 700
	Switchboard (calls from outside of France)	04 99 75 40 00
	Sales	0825 004 700
	Fax	0825 004 701
	Fax (calls from outside of France)	04 99 75 40 01
	<b>Corporate</b>	
	Technical Support	0825 004 719
	Customer Care	0825 338 339
	Switchboard	01 55 94 71 00
	Sales	01 55 94 71 00
	Fax	01 55 94 71 01

<b>Country (City) International Access Code Country Code City Code</b>	<b>Department Name or Service Area, Website and E-Mail Address</b>	<b>Area Codes, Local Numbers, and Toll-Free Numbers</b>
Germany (Langen) International Access Code: 00 Country Code: 49 City Code: 6103	Website: <a href="http://support.euro.dell.com">support.euro.dell.com</a> E-mail: <a href="mailto:tech_support_central_europe@dell.com">tech_support_central_europe@dell.com</a> Technical Support Home/Small Business Customer Care Global Segment Customer Care Preferred Accounts Customer Care Large Accounts Customer Care Public Accounts Customer Care Switchboard	06103 766-7200 0180-5-224400 06103 766-9570 06103 766-9420 06103 766-9560 06103 766-9555 06103 766-7000
Greece International Access Code: 00 Country Code: 30	Website: <a href="http://support.euro.dell.com">support.euro.dell.com</a> E-mail: <a href="mailto:support.euro.dell.com/gr/en/emailldell/">support.euro.dell.com/gr/en/emailldell/</a> Technical Support Gold Service Technical Support Switchboard Gold Service Switchboard Sales Fax	00800-44 14 95 18 00800-44 14 00 83 2108129810 2108129811 2108129800 2108129812
Grenada	General Support	toll-free: 1-866-540-3355
Guatemala	General Support	1-800-999-0136
Guyana	General Support	toll-free: 1-877-270-4609

<b>Country (City) International Access Code Country Code City Code</b>	<b>Department Name or Service Area, Website and E-Mail Address</b>	<b>Area Codes, Local Numbers, and Toll-Free Numbers</b>
<b>Hong Kong</b>	Website: <a href="http://support.ap.dell.com">support.ap.dell.com</a>	
International Access Code: 001	E-mail: <a href="mailto:apsupport@dell.com">apsupport@dell.com</a>	
Country Code: 852	Technical Support (Dimension™ and Inspiron™)	2969 3188
	Technical Support (OptiPlex™, Latitude™, and Dell Precision™)	2969 3191
	Technical Support (PowerApp™, PowerEdge™, PowerConnect™, and PowerVault™)	2969 3196
	Gold Queue EEC Hotline	2969 3187
	Customer Advocacy	3416 0910
	Large Corporate Accounts	3416 0907
	Global Customer Programs	3416 0908
	Medium Business Division	3416 0912
	Home and Small Business Division	2969 3155
<b>India</b>	Technical Support	1600 33 8045
	Sales	1600 33 8044
<b>Ireland (Cherrywood)</b>	Website: <a href="http://support.euro.dell.com">support.euro.dell.com</a>	
International Access Code: 16	E-mail: <a href="mailto:dell_direct_support@dell.com">dell_direct_support@dell.com</a>	
Country Code: 353	Technical Support	1850 543 543
City Code: 1	U.K. Technical Support (dial within U.K. only)	0870 908 0800
	Home User Customer Care	01 204 4014
	Small Business Customer Care	01 204 4014
	U.K. Customer Care (dial within U.K. only)	0870 906 0010
	Corporate Customer Care	1850 200 982
	Corporate Customer Care (dial within U.K. only)	0870 907 4499
	Ireland Sales	01 204 4444
	U.K. Sales (dial within U.K. only)	0870 907 4000
	Fax/Sales Fax	01 204 0103
	Switchboard	01 204 4444

<b>Country (City) International Access Code Country Code City Code</b>	<b>Department Name or Service Area, Website and E-Mail Address</b>	<b>Area Codes, Local Numbers, and Toll-Free Numbers</b>
Italy (Milan)	Website: support.euro.dell.com	
International Access Code: 00	E-mail: support.euro.dell.com/it/it/emaildell/	
Country Code: 39	<b>Home and Small Business</b>	
City Code: 02	Technical Support	02 577 826 90
	Customer Care	02 696 821 14
	Fax	02 696 821 13
	Switchboard	02 696 821 12
	<b>Corporate</b>	
	Technical Support	02 577 826 90
	Customer Care	02 577 825 55
	Fax	02 575 035 30
	Switchboard	02 577 821
<b>Jamaica</b>	General Support (dial from within Jamaica only)	1-800-682-3639

<b>Country (City) International Access Code Country Code City Code</b>	<b>Department Name or Service Area, Website and E-Mail Address</b>	<b>Area Codes, Local Numbers, and Toll-Free Numbers</b>
Japan (Kawasaki)	Website: <a href="http://support.jp.dell.com">support.jp.dell.com</a>	
International Access Code: 001	Technical Support (servers)	toll-free: 0120-198-498
Country Code: 81	Technical Support outside of Japan (servers)	81-44-556-4162
City Code: 44	Technical Support (Dimension™ and Inspiron™)	toll-free: 0120-198-226
	Technical Support outside of Japan (Dimension and Inspiron)	81-44-520-1435
	Technical Support (Dell Precision™, OptiPlex™, and Latitude™)	toll-free:0120-198-433
	Technical Support outside of Japan (Dell Precision, OptiPlex, and Latitude)	81-44-556-3894
	Technical Support (PDAs, projectors, printers, routers)	toll-free: 0120-981-690
	Technical Support outside of Japan (PDAs, projectors, printers, routers)	81-44-556-3468
	Faxbox Service	044-556-3490
	24-Hour Automated Order Service	044-556-3801
	Customer Care	044-556-4240
	Business Sales Division (up to 400 employees)	044-556-1465
	Preferred Accounts Division Sales (over 400 employees)	044-556-3433
	Large Corporate Accounts Sales (over 3500 employees)	044-556-3430
	Public Sales (government agencies, educational institutions, and medical institutions)	044-556-1469
	Global Segment Japan	044-556-3469
	Individual User	044-556-1760
	Switchboard	044-556-4300
Korea (Seoul)	Technical Support	toll-free: 080-200-3800
International Access Code: 001	Sales	toll-free: 080-200-3600
Country Code: 82	Customer Service (Seoul, Korea)	toll-free: 080-200-3800
City Code: 2	Customer Service (Penang, Malaysia)	604 633 4949
	Fax	2194-6202
	Switchboard	2194-6000



<b>Country (City) International Access Code Country Code City Code</b>	<b>Department Name or Service Area, Website and E-Mail Address</b>	<b>Area Codes, Local Numbers, and Toll-Free Numbers</b>
Latin America	Customer Technical Support (Austin, Texas, U.S.A.)	512 728-4093
	Customer Service (Austin, Texas, U.S.A.)	512 728-3619
	Fax (Technical Support and Customer Service) (Austin, Texas, U.S.A.)	512 728-3883
	Sales (Austin, Texas, U.S.A.)	512 728-4397
	SalesFax (Austin, Texas, U.S.A.)	512 728-4600 or 512 728-3772
<b>Luxembourg</b>	Website: <a href="http://support.euro.dell.com">support.euro.dell.com</a>	
International Access Code: 00	E-mail: <a href="mailto:tech_be@dell.com">tech_be@dell.com</a>	
Country Code: 352	Technical Support (Brussels, Belgium)	3420808075
	Home/Small Business Sales (Brussels, Belgium)	toll-free: 080016884
	Corporate Sales (Brussels, Belgium)	02 481 91 00
	Customer Care (Brussels, Belgium)	02 481 91 19
	Fax (Brussels, Belgium)	02 481 92 99
	Switchboard (Brussels, Belgium)	02 481 91 00
<b>Macao</b>	Technical Support	toll-free: 0800 582
Country Code: 853	Customer Service (Penang, Malaysia)	604 633 4949
	Transaction Sales	toll-free: 0800 581
<b>Malaysia (Penang)</b>	Technical Support (Dell Precision, OptiPlex, and Latitude)	toll-free: 1 800 88 0193
International Access Code: 00		
Country Code: 60	Technical Support (Dimension and Inspiron)	toll-free: 1 800 88 1306
City Code: 4	Technical Support (PowerEdge and PowerVault)	toll-free: 1800 88 1386
	Customer Service	04 633 4949
	Transaction Sales	toll-free: 1 800 888 202
	Corporate Sales	toll-free: 1 800 888 213

<b>Country (City) International Access Code Country Code City Code</b>	<b>Department Name or Service Area, Website and E-Mail Address</b>	<b>Area Codes, Local Numbers, and Toll-Free Numbers</b>
Mexico International Access Code: 00 Country Code: 52	Customer Technical Support  Sales  Customer Service  Main	001-877-384-8979 or 001-877-269-3383 50-81-8800 or 01-800-888-3355 001-877-384-8979 or 001-877-269-3383 50-81-8800 or 01-800-888-3355
Montserrat	General Support	toll-free: 1-866-278-6822
Netherlands Antilles	General Support	001-800-882-1519
Netherlands (Amsterdam) International Access Code: 00 Country Code: 31 City Code: 20	Website: <a href="http://support.euro.dell.com">support.euro.dell.com</a> Technical Support Technical Support Fax Home/Small Business Customer Care Relational Customer Care Home/Small Business Sales Relational Sales Home/Small Business Sales Fax Relational Sales Fax Switchboard Switchboard Fax	020 674 45 00 020 674 47 66 020 674 42 00 020 674 4325 020 674 55 00 020 674 50 00 020 674 47 75 020 674 47 50 020 674 50 00 020 674 47 50
New Zealand International Access Code: 00 Country Code: 64	E-mail (New Zealand): <a href="mailto:nz_tech_support@dell.com">nz_tech_support@dell.com</a> E-mail (Australia): <a href="mailto:au_tech_support@dell.com">au_tech_support@dell.com</a> Technical Support (for desktop and portable computers) Technical Support (for servers and storage) Home and Small Business Government and Business Sales Fax	0800 443 563 0800 505 098 0800 446 255 0800 444 617 0800 441 567 0800 441 566
Nicaragua	General Support	001-800-220-1006

<b>Country (City) International Access Code Country Code City Code</b>	<b>Department Name or Service Area, Website and E-Mail Address</b>	<b>Area Codes, Local Numbers, and Toll-Free Numbers</b>
Norway (Lysaker) International Access Code: 00 Country Code: 47	Website: support.euro.dell.com E-mail Support (portable computers): nor_nbk_support@dell.com E-mail Support (desktop computers): nor_support@dell.com E-mail Support (servers): nordic_server_support@dell.com	
	Technical Support	671 16882
	Relational Customer Care	671 17514
	Home/Small Business Customer Care	23162298
	Switchboard	671 16800
	Fax Switchboard	671 16865
<b>Panama</b>	General Support	001-800-507-0962
<b>Peru</b>	General Support	0800-50-669
<b>Poland (Warsaw)</b> International Access Code: 011 Country Code: 48 City Code: 22	Website: support.euro.dell.com E-mail: pl_support_tech@dell.com Customer Service Phone Customer Care Sales Customer Service Fax Reception Desk Fax Switchboard	57 95 700 57 95 999 57 95 999 57 95 806 57 95 998 57 95 999
<b>Portugal</b> International Access Code: 00 Country Code: 351	Website: support.euro.dell.com E-mail: support.euro.dell.com/pt/en/emaildell/ Technical Support Customer Care Sales Fax	707200149 800 300 413 800 300 410 or 800 300 411 or 800 300 412 or 21 422 07 10 21 424 01 12
<b>Puerto Rico</b>	General Support	1-800-805-7545
<b>St. Kitts and Nevis</b>	General Support	toll-free: 1-877-441-4731

<b>Country (City) International Access Code Country Code City Code</b>	<b>Department Name or Service Area, Website and E-Mail Address</b>	<b>Area Codes, Local Numbers, and Toll-Free Numbers</b>
St. Lucia	General Support	1-800-882-1521
St. Vincent and the Grenadines	General Support	toll-free: 1-877-270-4609
Singapore (Singapore)	Technical Support (Dimension and Inspiron)	toll-free: 1800 394 7430
International Access Code: 005 Country Code: 65	Technical Support (Optiplex, Latitude, and Precision)	toll-free: 1800 394 7488
	Technical Support (PowerEdge and PowerVault)	toll-free: 1800 394 7478
	Customer Service (Penang, Malaysia)	604 633 4949
	Transaction Sales	toll-free: 800 6011 054
	Corporate Sales	toll-free: 800 6011 053
<b>South Africa (Johannesburg)</b>	Website: <a href="http://support.euro.dell.com">support.euro.dell.com</a>	
International Access Code: 09/091	E-mail: <a href="mailto:dell_za_support@dell.com">dell_za_support@dell.com</a>	
Country Code: 27	Gold Queue	011 709 7713
City Code: 11	Technical Support	011 709 7710
	Customer Care	011 709 7707
	Sales	011 709 7700
	Fax	011 706 0495
	Switchboard	011 709 7700
<b>Southeast Asian and Pacific Countries</b>	Customer Technical Support, Customer Service, and Sales (Penang, Malaysia)	604 633 4810
<b>Spain (Madrid)</b>	Website: <a href="http://support.euro.dell.com">support.euro.dell.com</a>	
International Access Code: 00	E-mail: <a href="http://support.euro.dell.com/es/es/emaildell/">support.euro.dell.com/es/es/emaildell/</a>	
Country Code: 34	<b>Home and Small Business</b>	
City Code: 91	Technical Support	902 100 130
	Customer Care	902 118 540
	Sales	902 118 541
	Switchboard	902 118 541
	Fax	902 118 539
	<b>Corporate</b>	
	Technical Support	902 100 130
	Customer Care	902 115 236
	Switchboard	91 722 92 00
	Fax	91 722 95 83

<b>Country (City) International Access Code Country Code City Code</b>	<b>Department Name or Service Area, Website and E-Mail Address</b>	<b>Area Codes, Local Numbers, and Toll-Free Numbers</b>
Sweden (Upplands Vasby) International Access Code: 00 Country Code: 46 City Code: 8	Website: <a href="http://support.euro.dell.com">support.euro.dell.com</a> E-mail: <a href="mailto:swe_support@dell.com">swe_support@dell.com</a> E-mail Support for Latitude and Inspiron: <a href="mailto:Swe-nbk_kats@dell.com">Swe-nbk_kats@dell.com</a> E-mail Support for OptiPlex: <a href="mailto:Swe_kats@dell.com">Swe_kats@dell.com</a> E-mail Support for Servers: <a href="mailto:Nordic_server_support@dell.com">Nordic_server_support@dell.com</a> Technical Support Relational Customer Care Home/Small Business Customer Care Employee Purchase Program (EPP) Support Technical Support Fax Sales	08 590 05 199 08 590 05 642 08 587 70 527 20 140 14 44 08 590 05 594 08 590 05 185
Switzerland (Geneva) International Access Code: 00 Country Code: 41 City Code: 22	Website: <a href="http://support.euro.dell.com">support.euro.dell.com</a> E-mail: <a href="mailto:Tech_support_central_Europe@dell.com">Tech_support_central_Europe@dell.com</a> E-mail for French-speaking HSB and Corporate Customers: <a href="http://support.euro.dell.com/ch/fr/emaildell/">support.euro.dell.com/ch/fr/emaildell/</a> Technical Support (Home and Small Business) Technical Support (Corporate) Customer Care (Home and Small Business) Customer Care (Corporate) Fax Switchboard	0844 811 411 0844 822 844 0848 802 202 0848 821 721 022 799 01 90 022 799 01 01
Taiwan International Access Code: 002 Country Code: 886	Technical Support (portable and desktop computers) Technical Support (servers and storage) Corporate Sales	toll-free: 00801 86 1011 toll-free: 00801 60 1256 toll-free: 00801 651 227
Thailand International Access Code: 001 Country Code: 66	Technical Support (Optiplex, Latitude, and Precision) Technical Support (PowerEdge and PowerVault) Customer Service (Penang, Malaysia) Sales	toll-free: 1800 0060 07 toll-free: 1800 0600 09 604 633 4949 toll-free: 0880 060 09

<b>Country (City) International Access Code Country Code City Code</b>	<b>Department Name or Service Area, Website and E-Mail Address</b>	<b>Area Codes, Local Numbers, and Toll-Free Numbers</b>
Trinidad/Tobago	General Support	1-800-805-8035
Turks and Caicos Islands	General Support	toll-free: 1-866-540-3355
U.K. (Bracknell)	Website: <a href="http://support.euro.dell.com">support.euro.dell.com</a>	
International Access Code: 00	Customer Care website: <a href="http://support.euro.dell.com/uk/en/ECare/Form/Home.asp">support.euro.dell.com/uk/en/ECare/Form/Home.asp</a>	
Country Code: 44		
City Code: 1344	E-mail: <a href="mailto:dell_direct_support@dell.com">dell_direct_support@dell.com</a>	
	Technical Support (Corporate/Preferred Accounts/PAD [1000+ employees])	0870 908 0500
	Technical Support (direct/PAD and general)	0870 908 0800
	Global Accounts Customer Care	01344 373 186
	Home and Small Business Customer Care	0870 906 0010
	Corporate Customer Care	01344 373 185
	Preferred Accounts (500–5000 employees) Customer Care	0870 906 0010
	Central Government Customer Care	01344 373 193
	Local Government & Education Customer Care	01344 373 199
	Health Customer Care	01344 373 194
	Home and Small Business Sales	0870 907 4000
	Corporate/Public Sector Sales	01344 860 456
	Home and Small Business Fax	0870 907 4006
Uruguay	General Support	toll-free: 000-413-598-2521

<b>Country (City) International Access Code Country Code City Code</b>	<b>Department Name or Service Area, Website and E-Mail Address</b>	<b>Area Codes, Local Numbers, and Toll-Free Numbers</b>
U.S.A. (Austin, Texas)	Automated Order-Status Service	toll-free: 1-800-433-9014
International Access Code: 011 Country Code: 1	AutoTech (portable and desktop computers) <b>Consumer</b> (Home and Home Office) Technical Support Customer Service DellNet™ Service and Support  Employee Purchase Program (EPP) Customers Financial Services website: <a href="http://www.dellfinancialservices.com">www.dellfinancialservices.com</a> Financial Services (lease/loans) Financial Services (Dell Preferred Accounts [DPA]) <b>Business</b> Customer Service and Technical Support Employee Purchase Program (EPP) Customers Printers and Projectors Technical Support <b>Public</b> (government, education, and healthcare) Customer Service and Technical Support Employee Purchase Program (EPP) Customers Dell Sales  Dell Outlet Store (Dell refurbished computers) Software and Peripherals Sales Spare Parts Sales Extended Service and Warranty Sales Fax Dell Services for the Deaf, Hard-of-Hearing, or Speech-Impaired	toll-free: 1-800-247-9362  toll-free: 1-800-624-9896 toll-free: 1-800-624-9897 toll-free: 1-877-Dellnet (1-877-335-5638) toll-free: 1-800-695-8133  toll-free: 1-877-577-3355 toll-free: 1-800-283-2210  toll-free: 1-800-822-8965 toll-free: 1-800-695-8133 toll-free: 1-877-459-7298  toll-free: 1-800-456-3355 toll-free: 1-800-234-1490 toll-free: 1-800-289-3355 or toll-free: 1-800-879-3355 toll-free: 1-888-798-7561 toll-free: 1-800-671-3355 toll-free: 1-800-357-3355 toll-free: 1-800-247-4618 toll-free: 1-800-727-8320 toll-free: 1-877-DELLITY (1-877-335-5889)
U.S. Virgin Islands	General Support	1-877-673-3355
Venezuela	General Support	8001-3605





# Index

## A

audio. See *sound*

## B

battery

- problems, 19
- replacing, 77

BIOS, 82

boot sequence, 88

- changing, 88-89
- option settings, 88

booting

- to a USB device, 88

## C

cards

- installing PCI, 58
- PCI, 58
- PCI Express slots, 51
- PCI slots, 51
- removing PCI, 60
- slots, 51, 58
- types supported, 58

CD/DVD drive

- activity light, 49
- eject button, 49
- installing, 74
- installing second, 75
- problems, 20
- removing, 73

CD-RW drive

- problems, 20

CDs

- copying, 16
- playing, 14

Check Disk, 21

computer

- components inside, 53
- crashes, 24-25
- inside view, 53
- restore to previous state, 41-42
- stops responding, 24

connectors

- headphone, 49
- keyboard, 51
- line-in, 51
- line-out, 51
- microphone, 51
- modem, 51
- mouse, 50
- network adapter, 51
- parallel, 50
- power, 51
- serial, 51
- sound, 51
- USB, 49, 51
- video, 51

copying CDs

- helpful tips, 18

copying CDs and DVDs, 16

copying DVDs

- helpful tips, 18

cover

- cover latch, 51
- removing, 52
- replacing, 78

## D

Dell

- contacting, 94
- Dell Diagnostics, 38
- support policy, 92
- support site, 8

Dell Premier Support

- website, 7

diagnostic lights, 35

diagnostics

- Dell, 38
- lights, 35, 50

display. See *monitor*

documentation

- End User License Agreement, 7
- ergonomics, 7
- online, 8
- Product Information Guide, 7
- regulatory, 7
- safety, 7
- warranty, 7

drivers

- about, 40
- identifying, 40

drives  
  hard drive, 66  
  installing CD/DVD, 74  
  installing floppy, 71  
  installing hard drive, 68  
  problems, 19  
  removing CD/DVD, 73  
  removing floppy, 70  
  removing hard drive, 66  
  second CD/DVD drive, 75

DVD drive  
  problems, 20

DVDs  
  copying, 16  
  playing, 14

**E**

e-mail  
  problems, 21

End User License Agreement, 7

ergonomics information, 7

error messages  
  about, 22  
  diagnostic lights, 35

**F**

floppy drive  
  activity light, 50  
  eject button, 49  
  installing, 71  
  removing, 70

front panel  
  insert, 63  
  removing, 62

## **H**

hard drive  
  activity light, 49  
  installing, 68  
  problems, 21  
  removing, 66

hardware  
  Dell Diagnostics, 38

Hardware Troubleshooter, 46

headphone  
  connector, 49

Help and Support Center, 8

help file  
  Windows Help and Support Center, 8

Hyper-Threading, 18

## **I**

IEEE 1394  
  problems, 23

installing parts  
  before you begin, 47  
  recommended tools, 47  
  turning off your computer, 47

Internet  
  problems, 21

internet  
  connection, about, 12  
  connection, options, 12  
  connection, setting up, 13

## **K**

keyboard  
  connector, 51  
  problems, 24

## **L**

labels  
  Microsoft Windows, 8  
  Service Tag, 8, 50

lights  
  back of computer, 35  
  CD/DVD drive activity, 49  
  diagnostic, 35, 50  
  floppy drive activity, 50  
  hard drive activity, 49  
  power, 50

## **M**

memory  
  adding, 55  
  problems, 26

messages  
  error, 22

microphone  
  connector, 51

Microsoft Windows label, 8

modem  
connector, 51  
problems, 21

monitor  
blank, 32  
hard to read, 33  
problems, 32

motherboard. See *system board*

mouse  
connector, 50  
problems, 27

**N**

network  
connector, 51  
Network Setup Wizard, 12  
problems, 28  
setting up, 11

Network Setup Wizard, 12

**P**

password  
clearing, 90  
jumper, 90

PC Restore, 43

PCI cards  
installing, 58  
removing, 60

playing CDs and DVDs, 14

power  
button, 49  
connector, 51  
light, 50  
problems, 28

power light  
conditions, 28

printer  
cable, 9  
connecting, 9  
parallel, 10  
problems, 29  
setting up, 9  
USB, 9

problems  
battery, 19  
blue screen, 25  
CD drive, 20  
CD-RW drive, 20  
computer crashes, 24-25  
computer stops responding, 24  
Dell Diagnostics, 38  
diagnostic lights, 35  
drives, 19  
DVD drive, 20  
e-mail, 21  
error messages, 22  
general, 24  
hard drive, 21  
IEEE 1394, 23  
Internet, 21  
keyboard, 24  
memory, 26  
modem, 21  
monitor is blank, 32

problems (continued)  
monitor is hard to read, 33  
network, 28  
power, 28  
power light conditions, 28  
printer, 29  
program crashes, 25  
program stops responding, 25  
programs and Windows  
compatibility, 25  
restore to previous state, 41-42  
scanner, 30  
screen is blank, 32  
screen is hard to read, 33  
software, 25-26  
sound and speakers, 31  
technical support policy, 92  
troubleshooting tips, 19  
video and monitor, 32  
volume adjusting, 31

Product Information Guide, 7

Program Compatibility  
Wizard, 25

**R**

regulatory information, 7

**S**

safety instructions, 7

scanner  
problems, 30

screen. See *monitor*

- Service Tag, 8, 50
- settings
  - system setup, 82
- software
  - Hyper-Threading, 18
  - problems, 25-26
- sound
  - problems, 31
  - volume, 31
- sound connectors
  - line-in, 51
  - line-out, 51
- speaker
  - problems, 31
  - volume, 31
- specifications, 79
- support
  - contacting Dell, 94
  - policy, 92
- support website, 8
- system board, 54
- System Restore, 41-42
- system setup, 82
  - entering, 83
  - options, 84
  - screens, 83

## T

- technical support
  - policy, 92
- troubleshooting
  - Dell Diagnostics, 38
  - diagnostic lights, 35
  - Hardware Troubleshooter, 46
  - Help and Support Center, 8
  - restore to previous state, 41-42
  - tips, 19

## U

- USB
  - booting to devices, 88
  - connectors, 49, 51

## V

- video
  - connector, 51
  - problems, 32
- voltage selection switch, 51
- volume
  - adjusting, 31

## W

- warranty information, 7
- Windows XP
  - Device Driver Rollback, 41
  - Hardware Troubleshooter, 46
  - Help and Support Center, 8
  - Hyper-Threading, 18
  - Network Setup Wizard, 12
  - Program Compatibility Wizard, 25
  - scanner, 31
  - System Restore, 41-42
- wizards
  - Network Setup Wizard, 12
  - Program Compatibility Wizard, 25